

PILOT'S MANUAL FOR

BOEING B-17

FLYING FORTRESS



SECTION I DESCRIPTION

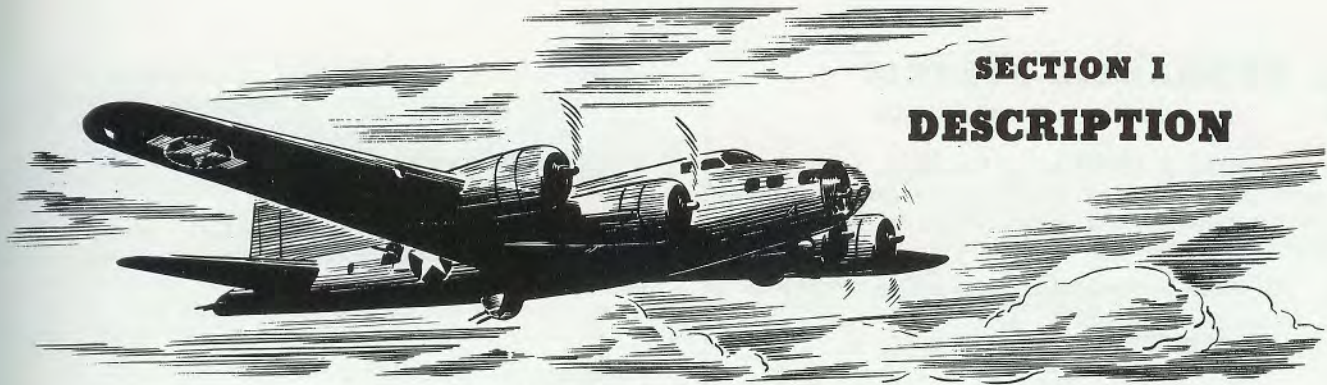

Figure 1 - B-17F in Flight

1. AIRPLANE.

a. Model B-17F and G bombardment airplanes are four-engine-midwing monoplanes. The approximate over-all dimensions are: length, 74 feet 9 inches; height, taxiing position, 19 feet 1 inch; span, 103 feet 9 inches.

b. Electrically operated landing gear, tail gear, wing flaps, bomb bay doors, and hydraulically operated brakes and cowl flaps are provided.

c. The crew includes pilot, copilot, navigator, bombardier, upper turret gunner, lower turret gunner, radio operator, side gunner(s), and tail gunner. The airplane can be entered either through the main entrance door on the right side of the airplane just forward of the horizontal stabilizer, or through the front hatch in the bottom of the fuselage below the pilot's compartment.

d. Defensive armament of the B-17F consists of three turrets, each mounting two .50 calibre machine guns, and five single flexibly mounted .50 calibre machine guns. The B-17G has an additional power turret just below the nose of the airplane and controlled from the bombardier's compartment.

e. Provisions are made for loading 2000-pound or smaller bombs on racks within the bomb bay, and one bomb, up to 4000 pounds may be carried under each wing.

f. Automatic flight control equipment is provided.

2. POWER PLANT.

a. ENGINES. - The Wright model R-1820-97 engines are air-cooled, nine-cylinder radial aircraft

engines, equipped with integral reduction gears through which the propellers are driven.

b. TURBOSUPERCHARGERS. - A type B-2 General Electric turbosupercharger is provided for each engine to boost manifold pressure for take-off and high-altitude flight. Superchargers are controlled by automatic hydraulic regulators adjusted from the pilot's control pedestal.

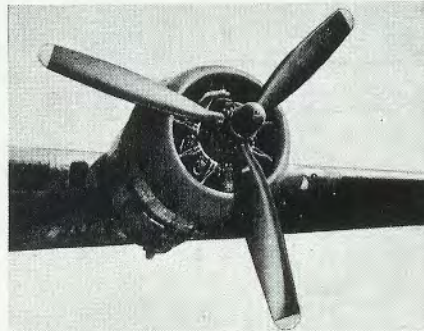

Figure 3 - Power Plant

c. PROPELLERS. - The Hamilton standard three-blade propellers are hydromatically controlled with constant-speed and full feathering provisions.

d. AUTOMATIC ENGINE CONTROL. - Should engine control cables be shot away, four of the controls will automatically assume predetermined positions: throttles, wide open; superchargers, 65 percent power; intercoolers, cold; and propellers, 1850 rpm. Functioning of the automatic control at one unit will not affect placement of controls at other units, or of similar controls on other engines.



Figure 2
Three-quarter
Rear View

3. HYDRAULIC SYSTEM

a. SERVICE SYSTEM. - Hydraulic pressure for operating brakes and cowl flaps is supplied by an electric motor-driven pump, or by an accumulator while the pump is not operating.

(1) When the hydraulic pump switch on the pilot's

control panel is in the "AUTO" position, pressure is automatically regulated by a pressure cut-out switch, starting the pump when pressure drops to 600 pounds and stopping the pump when the pressure builds up to 800 pounds. In case the automatic pressure switch fails, pressure may be maintained by holding the hydraulic pump switch in the "MANUAL" position. A relief valve opens if pressure in the system reaches 900 pounds.

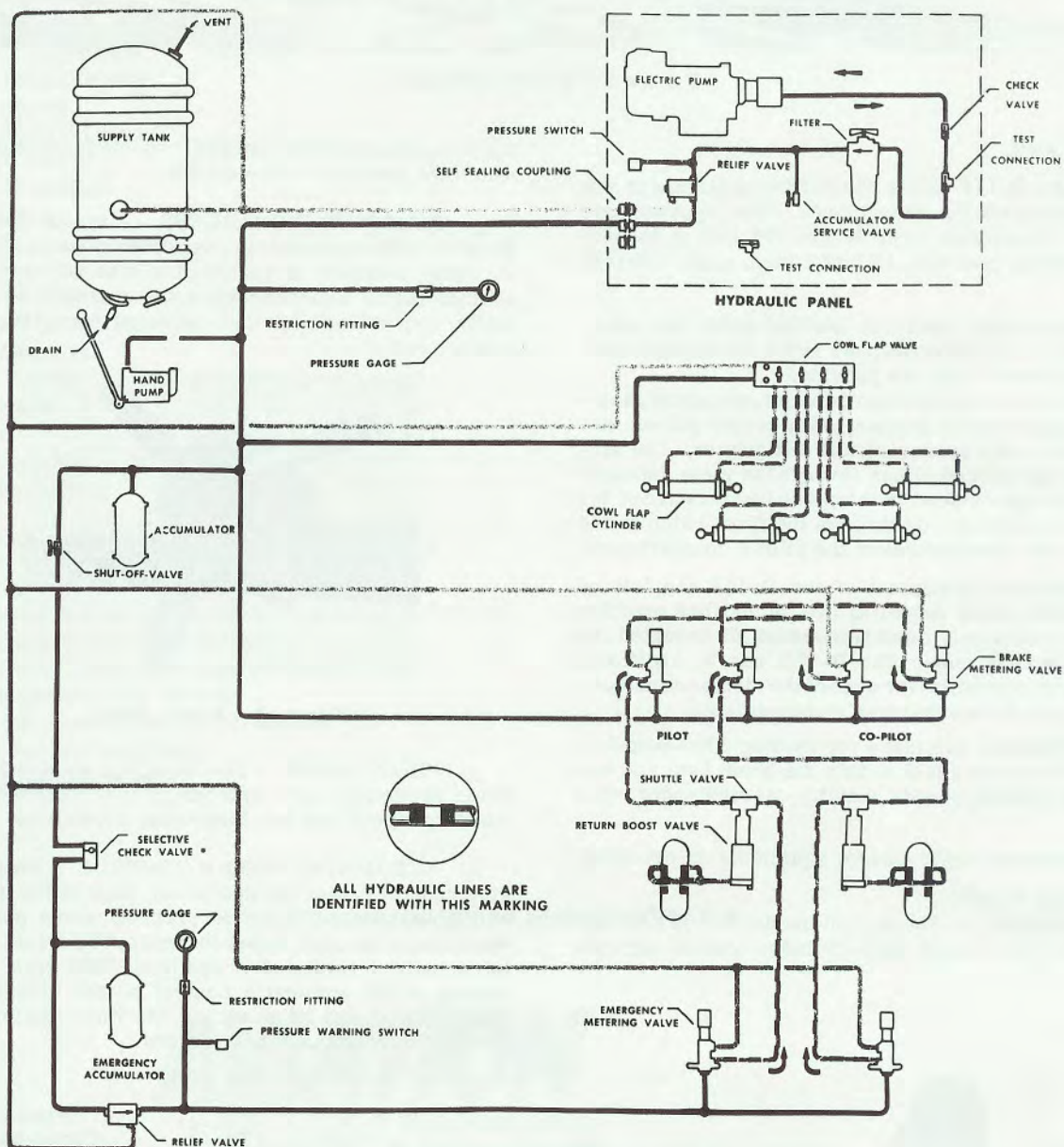

NOTES

*VALVE NOT INSTALLED ON SOME AIRPLANES.
 INDICATED METERING VALVE FLOW APPLIES BRAKES.
 RELEASE OF BRAKES REVERSES FLOW.
 PARKING BRAKES OPERATED FROM CO-PILOT'S METERING VALVES.

— SUPPLY LINES
 — PRESSURE LINES
 — RETURN LINES
 — EMERGENCY BRAKE SYSTEM LINES
 — PRESSURE AND RETURN LINES (ALTERNATELY)
 NOTE: FOR AIRPLANES WITH DUAL DUPLEX BRAKES.

Figure 4 - Hydraulic Flow Diagram

WARNING

Should leakage occur in the hydraulic system, the pump must be stopped to prevent loss of fluid. Remove the hydraulic pump switch fuse in the station 4 fuse panel, or disconnect the electrical receptacle at the pressure switch.

(2) In some airplanes the hydraulic pump is controlled by an "ON-OFF" switch on the pilot's control panel. This switch must be "ON" to maintain pressure automatically.

b. **EMERGENCY BRAKE SYSTEM.** - A spare accumulator and auxiliary metering valves provide emergency brake operation. A red warning lamp on the pilot's instrument panel lights when pressure in the emergency system falls to approximately 700 pounds per square inch. To charge the emergency accumulator, open the manual shut-off valve. If a selective check valve is installed, place it in "SERVICING" position, unless it is lockwired in "NORMAL" position. (These units are located on the right side wall at the rear of the control cabin. See figure 5.) Build up 800 pounds pressure in the system, then return the selective check valve to "NORMAL" position and close the manual shut-off valve.

NOTE

The emergency brake system has been eliminated from the later model airplanes.

c. **PRESSURE GAGES.** - Pressure in the service and emergency brake systems is indicated by two gages on the pilot's instrument panel.

d. **HAND PUMP.** - A hand pump on the side wall at the right of the copilot is used to supply pressure for ground service operations, and to recharge the accumulators if the electric pump fails.

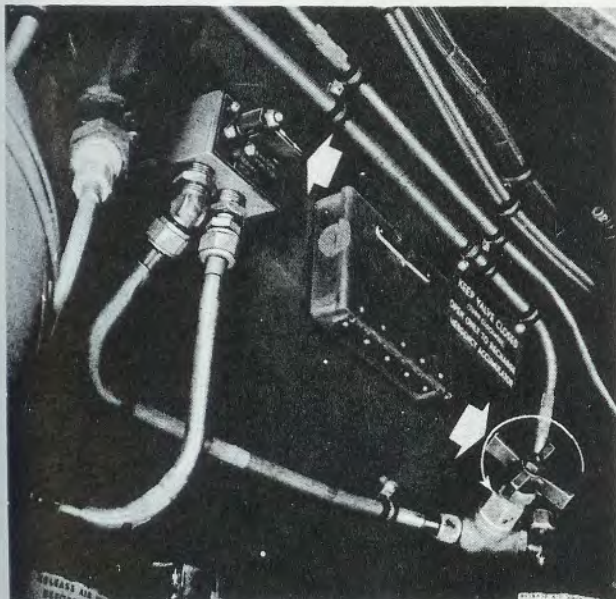

Figure 5 - Servicing Emergency Accumulator

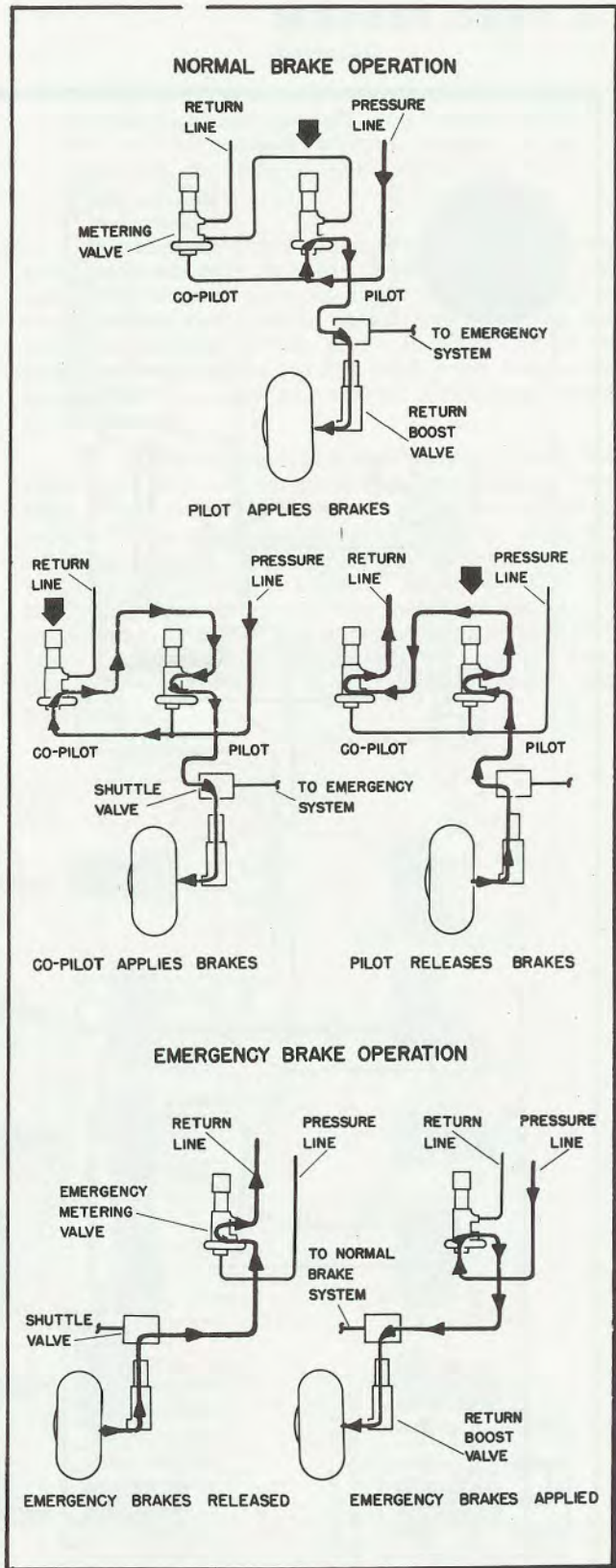
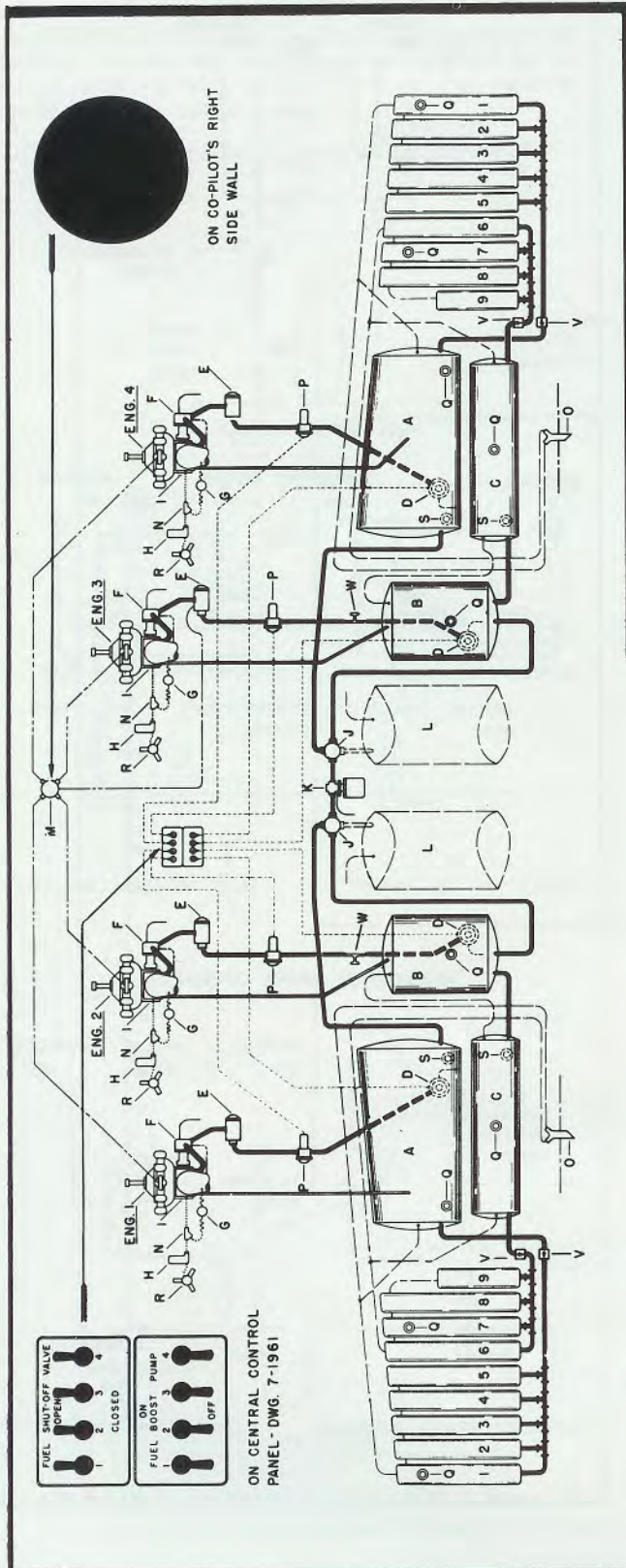

Figure 6 - Brake Operation Diagram

4. FUEL SYSTEM



The fuel system consists of four independent single-engine systems as shown in figure 7. The fuel supply for one engine can be used for another engine only by transferring fuel from one engine tank to another through the fuel transfer system. All fuel tanks are the self-sealing type.

a. **FUEL BOOST PUMPS.** - Electrically driven fuel boost pumps, controlled by toggle switches on the central control panel, supply pressure required for engine starting, and supplement the engine-driven fuel pumps for take-off and for high-altitude flight. The boost pumps are normally turned off after the climb from take-off is well under way and started again at 15,000 to 18,000 feet to prevent vaporization in the fuel lines to the engine-driven pumps. Booster pump pressure at engine No. 3 fuel strainer is used to supply the cylinder head primer.

b. **FUEL SHUT-OFF VALVES.** - Fuel shut-off valves, controlled by switches on the central control panel, are installed in the fuel lines between each booster pump and fuel strainer, providing immediate stoppage of flow to an engine in case a line is severed.

Figure 7 - Fuel Flow Diagram

c. PRIMER. - The cylinder head primer has positions corresponding to each of the four engines, and an "OFF" position in which the primer handle is locked. To operate, push the handle down, turn the valve to the engine position required, and then withdraw the handle and pump the charge to the engine.

IMPORTANT

Pressure from No. 3 fuel booster pump is on the suction side of the primer and overpriming will result, if the handle is left in the withdrawn position. Therefore, each priming operation must terminate with the handle returned to the locked position.

d. FUEL TRANSFER SYSTEM.

(1) Fuel is transferred by means of an electric motor-driven pump and two selector valves. The motor switch and selector valve handles are in the rear of the control cabin below the door leading to the bomb bay. Direct transfer can only be made across the center line of the airplane. (See figure 8 for fuel transfer procedure.)

WARNING

Do not use bomb bay valve position when bomb bay tanks are not installed. It is recommended that a 6-inch length of hose, plugged at the outer end, be attached to the bomb bay valve ports.

(2) An emergency hand-operated fuel pump, mounted on the rear bulkhead of the bomb bay, can be substituted for the electric-driven transfer pump by disconnecting the electric pump lines from the fuel transfer selector valves at the forward end of the bomb bay and connecting the hand pump lines. The hand pump can also be used as a refueling pump. (See figure 60.)

(3) Airplanes equipped with auxiliary wing fuel cells have shut-off valves in the lines leading from each group of cells. These valves are controlled by handles in the radio compartment or in the bomb bay near bulkhead No. 5. (See figure 59.) Keep auxiliary cell shut-off valves "CLOSED" (handles out) at all times except when transferring fuel from auxiliary to main tanks. Transfer fuel only when fuel level of main tanks has dropped to 100 gallons per engine. After transfer, return valve to "CLOSED" (handle out) position.

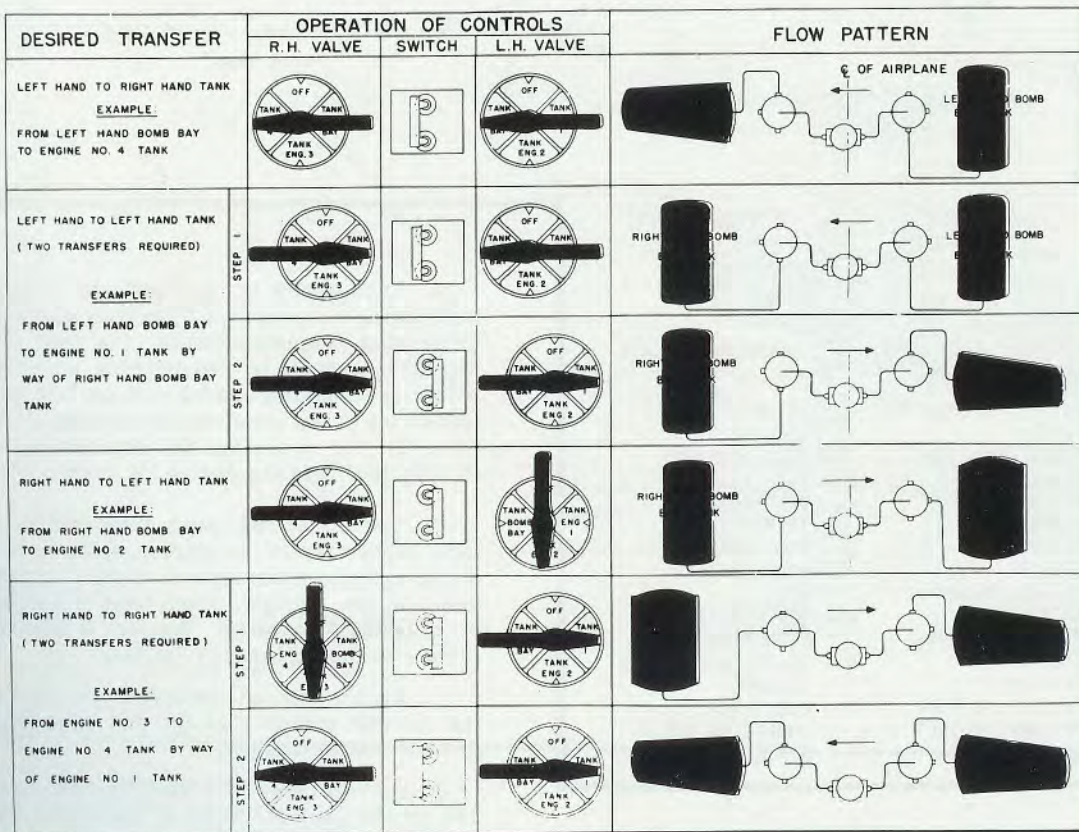

Figure 8 - Fuel Transfer Diagram

6. ELECTRICAL SYSTEM

a. A 24-volt d-c system distributes power from four engine-driven generators and from three storage batteries in the leading edges of the wing, just out-board of the fuselage. Three solenoid-operated battery switches are controlled by toggle switches on the pilot's control panel.

b. A gasoline engine-driven generator unit stowed in the rear fuselage compartment may be operated on

the ground to provide auxiliary electric power for recharging batteries and for limited radio operation.

c. Alternating current for the Autosyn instruments, drift meter, radio compass, and warning signals transformer is furnished by two inverters under the pilot's and copilot's seats. A double-throw switch on the pilot's control panel selects the inverter to be used: in "NORMAL" position the left inverter is on; in "ALTERNATE" position the right inverter is on. Both inverters are off when the switch is centered.

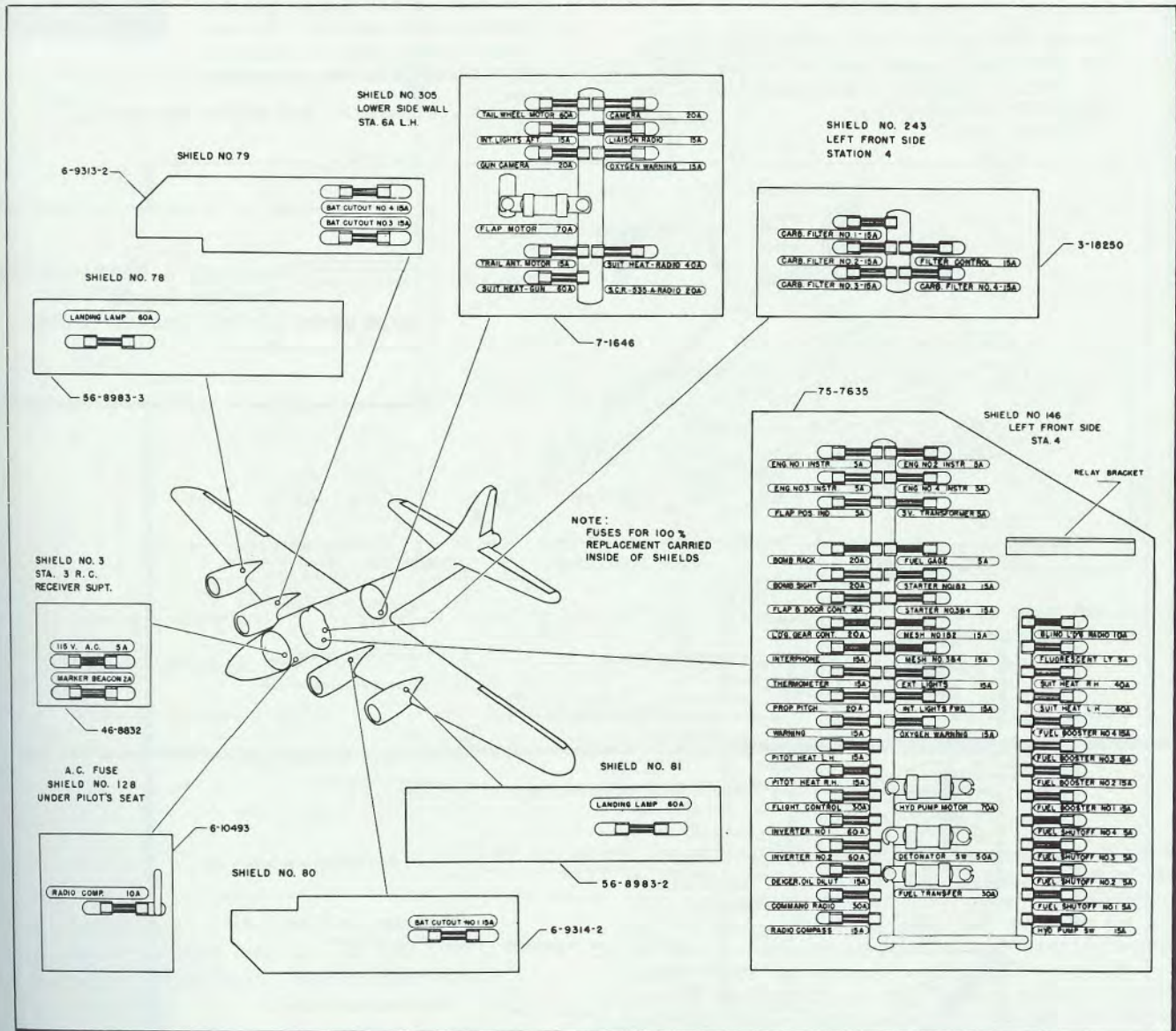

Figure 10 - Fuse Location Diagram

7. HEATING

a. **GLYCOL HEATING SYSTEM.** - Cabin heat is supplied by a hot air system in which heat is transferred to the ventilating air from a glycol system in the No. 2 nacelle. Flow of heated air to the cabin is controlled by a damper at the pilot's left. Defroster air is controlled by a red knob in the "v" of the pilot's windshield and by a control near the outlet in the bombardier's air duct. Fill glycol tank with approved mixture only; do not dilute with water.

CAUTION

During starting and ground operation of engines, the cabin heat control must be in the "OFF" or "COLD" position to prevent glycol in the system from boiling away.

b. **AUXILIARY HEATING SYSTEM.** - A similar glycol system, installed in the No. 3 nacelle of some airplanes, supplies eight radiator-fan heating and defrosting units in various locations in the airplane. Fan motors are thermostatically controlled and the flow of heating air is regulated by a damper at each unit.

c. **SUIT HEATER OUTLET.** - Ten receptacles for plugging in electric suit heaters are provided at various crew stations. The heat output of each suit is controlled by a rheostat on the receptacle box.



Figure 12 - Suit Heater Receptacle

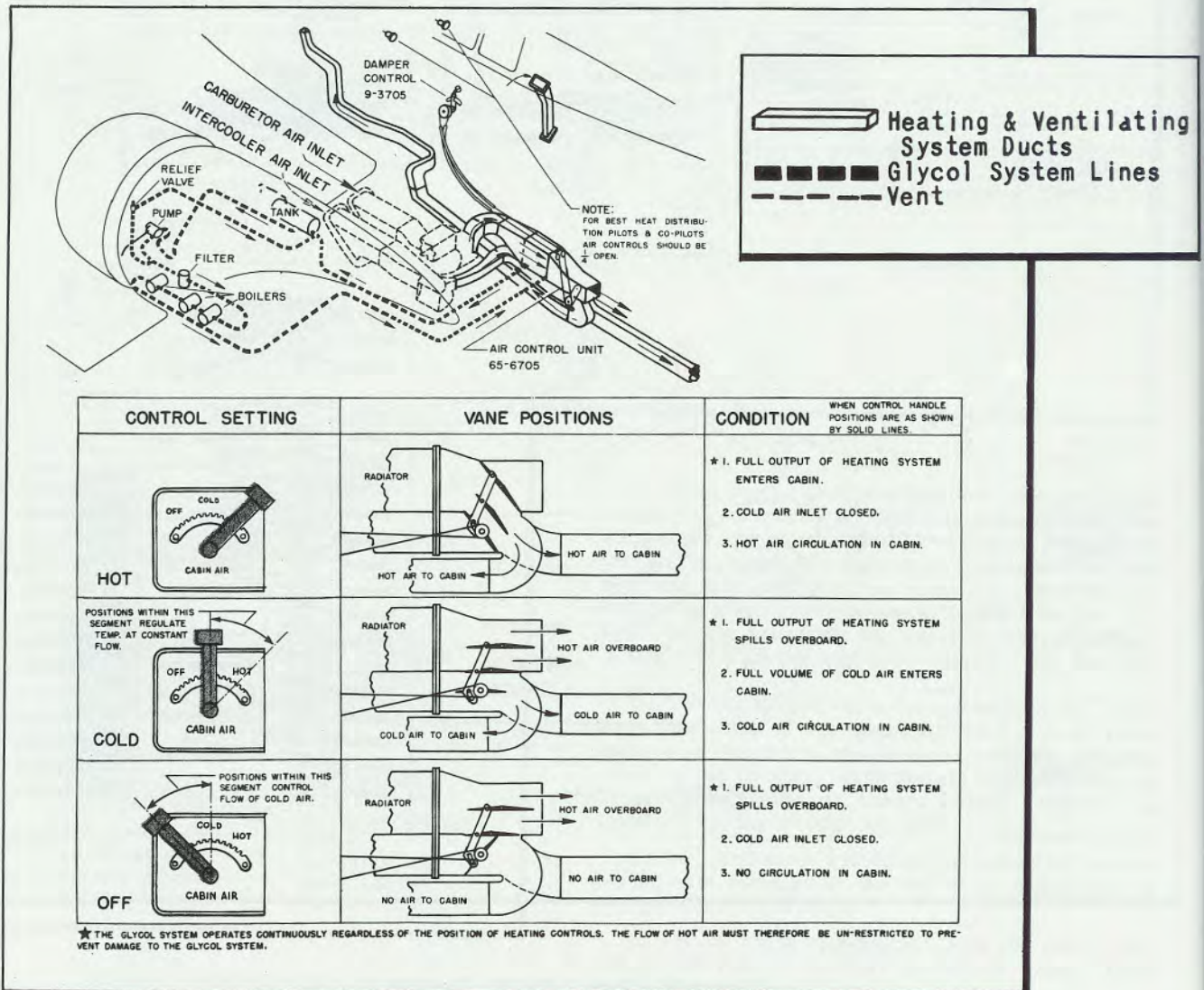

Figure 11 - Heating System Diagram

8. VACUUM AND DE-ICING SYSTEM

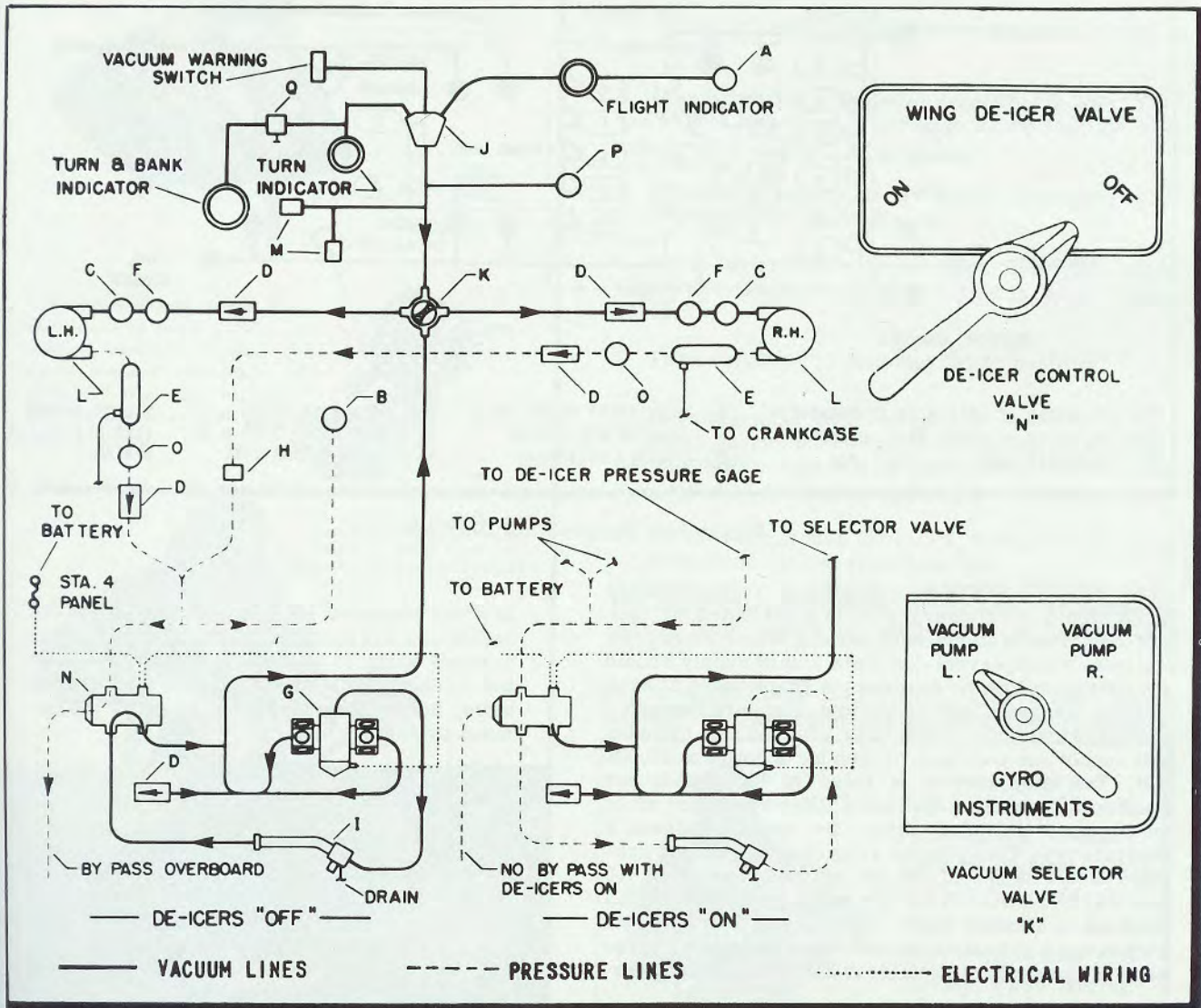

Figure 13 - Vacuum and De-icer Flow Diagram

KEY TO FIGURE 13

A - SUCTION GAGE	I - OIL SEPARATOR
B - DE-ICER PRESSURE GAGE	J - MANIFOLD (INSTR. TUBING)
C - SUCTION RELIEF VALVE	K - SELECTOR VALVE
D - CHECK VALVE	L - VACUUM PUMP
E - OIL SEPARATOR	M - SHUT-OFF VALVE
F - PRESSURE RELIEF VALVE	N - DE-ICER CONTROL VALVE
G - ROTARY DISTRIBUTING VALVE	O - PRESSURE RELIEF VALVE
H - TEST CONNECTION	P - SHUT-OFF VALVE
	Q - VALVE

Vacuum pumps are driven by engines Nos. 2 and 3. The selector valve on the side wall at the left of the pilot permits selection of either pump for deflation of de-icer shoes and at the same time provides the use of the other pump for all other vacuum-operated equipment. When the de-icer control valve is "ON," it directs the discharge of both vacuum pumps to the de-icer distributor valve and also starts the distributor valve motors. When it is "OFF" the exhaust from both pumps is bypassed overboard, and the distributor motor is stopped.

9. OXYGEN SYSTEM

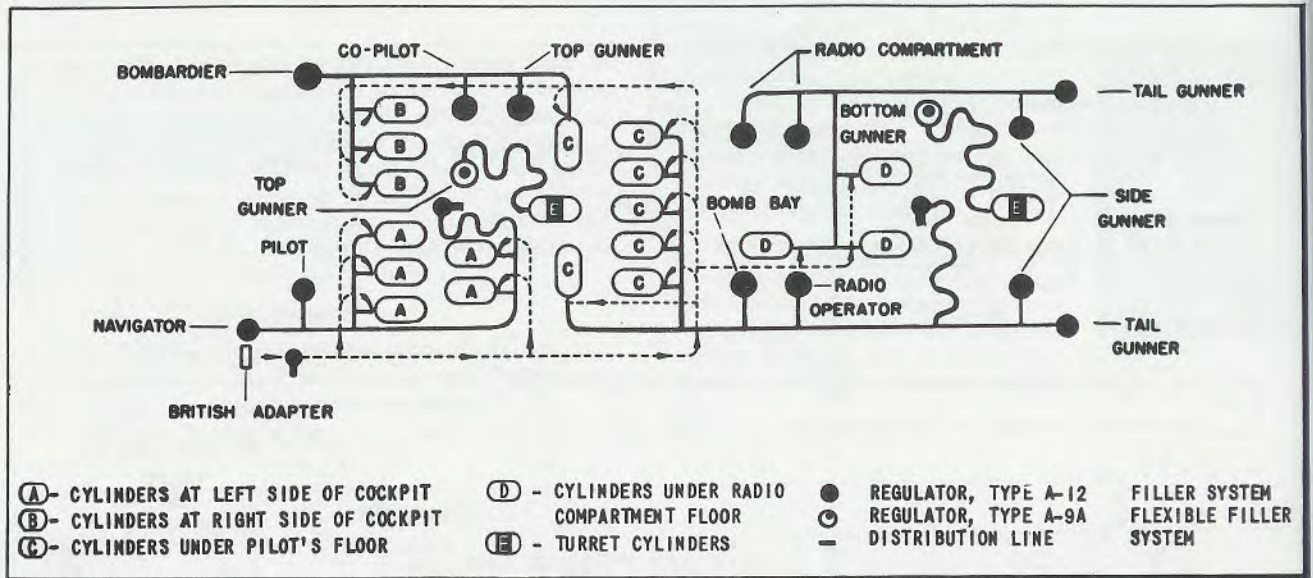

Figure 14 - Oxygen Flow Diagram

a. **SUPPLY SYSTEM.** - Breathing oxygen is stored in 18 type G-1 cylinders and is distributed by four self-contained systems, each serving two or more crew stations, which prevent complete loss of supply should a distribution line be severed. A check valve at each cylinder prevents loss of system pressure through a punctured cylinder. Each fully charged G-1 cylinder will supply one man with oxygen for 5 hours at 30,000 feet. The main system is filled to 400 pounds per square inch pressure through a filler valve just aft of the forward entrance hatch. On some airplanes a separate type F-1 cylinder at each power turret provides 2-1/2 hours of oxygen for one man at 30,000 feet and is refilled from the main system through a valve on a flexible hose. (See figure 15) Portable oxygen units provided for each crew member may be filled at the recharging valve at any demand regulator.

b. **REGULATORS.** - A type A-12 demand regulator and an indicator panel are located at each crew station. (See figure 16 for operation.) Power turrets are equipped with A-9A constant-flow regulators in airplanes having separate turret cylinders.

c. **INDICATOR PANELS.** - When oxygen flows from the regulator, the ball in the indicator bounces up in the glass tube; when flow stops, the ball falls. Do not be surprised if the indicator shows no oxygen flowing when the airplane is on the ground and the auto-mix is "ON," as the regulator is not necessarily supposed to add oxygen at ground level. The gage shows the pressure in the supply cylinders for that station. The warning signal lights when that pressure falls below 100 pounds per square inch.

NOTE

In some airplanes 15 constant-flow type A-9A regulators are provided. This installation has a relief valve in the filler system, and does not have the indicator panels or the portable units, but is essentially the same as the demand system.

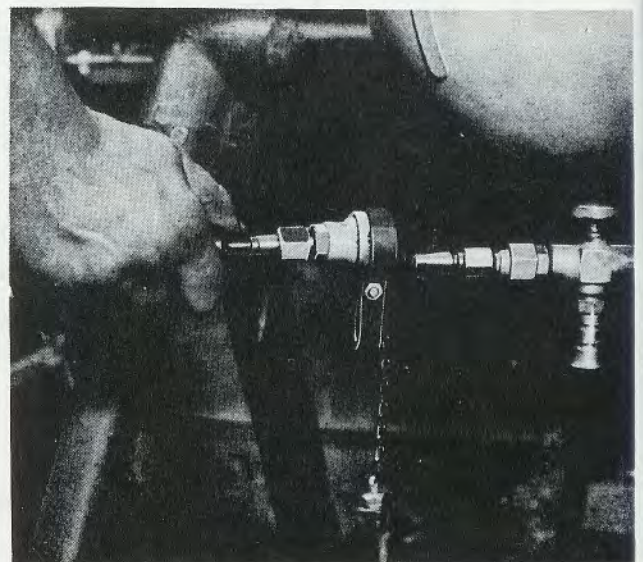

Figure 15 - Refilling Turret Oxygen Cylinder

USE OXYGEN INTELLIGENTLY



Figure 16 - Use of Oxygen

CAUTION

EXERCISE EXTREME CAUTION TO INSURE THAT OXYGEN EQUIPMENT DOES NOT BECOME CONTAMINATED WITH OIL OR GREASE. FIRE OR EXPLOSION MAY RESULT WHEN EVEN SLIGHT TRACES OF OIL OR GREASE COME IN CONTACT WITH OXYGEN UNDER PRESSURE.

1. Have your own mask which has been checked for fit by the oxygen officer.
2. Carry your bail-out cylinder charged to 1800 pounds.

3. Check to see that there is a portable "walk-around" unit at each station, filled to 400 pounds, and in working order.
4. Check system pressure before flight; it should be 400 pounds.
5. Check function of demand regulator in both "ON" and "OFF" positions. Flow gage should function when auto-mix is "OFF."
6. Check knurled collar on elbow connecting mask hose to regulator for tightness.
7. Open emergency valve to check flow; then close. This valve should not be open except in case of emergency.
8. Turn regulator to auto-mix "ON" position.
9. Use auto-mix "OFF" only -
When oxygen officer advises the use of pure oxygen before take-off, in which case, use it all the way up as protection against "bends."

When treating men for shock, loss of blood, or as protection against poisonous gas.

10. Start using oxygen at 10,000 feet. At night use oxygen from ground up, with auto-mix in "ON" position.
11. In flight above 10,000 feet, always use "walk-around" unit when moving from one station to another.



Figure 17 - Portable Oxygen Unit in Use

MAN HOURS OF AVAILABLE OXYGEN

BLACK FIGURES INDICATE AUTO-MIX "ON"

RED FIGURES INDICATE AUTO-MIX "OFF"

CAUTION—The auto-mix in the off position rapidly diminishes the available oxygen supply. Do not use this position unless it is necessary to get *pure oxygen!*

AIRCO REGULATORS TYPE A-12

PIONEER REGULATORS TYPE A-12

GROUP I (5 G-1 Cylinders)
Pilot, Navigator and Top Turret Filler

Gage Pres.									
	400	350	300	250	200	150	100	50	
Alt. Ft.									
40,000	41.5	35.6	29.4	23.6	17.8	12.0	5.8		E
35,000	29.5	25.3	20.9	16.8	12.6	8.5	4.0		M
30,000	21.5	18.5	15.2	12.2	9.2	6.0	3.0		E
25,000	16.5	14.1	11.5	9.0	7.0	4.7	2.0		R
20,000	13.0	11.1	9.2	7.4	5.5	3.7	1.5		G
15,000	10.0	8.6	7.0	5.7	4.0	3.9	1.4		E
10,000	8.0	6.8	5.6	4.5	3.4	2.3	1.1		N
5,000	6.5	5.5	4.6	3.7	2.8	1.8	1.0		C
S. L.	5.5	4.7	3.9	3.1	2.3	1.5	0.7		Y

Gage Pres.									
	400	350	300	250	200	150	100	50	
Alt. Ft.									
40,000	41.5	35.6	29.4	23.6	17.8	12.0	5.8		E
35,000	29.5	25.3	20.9	16.8	12.6	8.5	4.0		M
30,000	21.5	18.5	15.2	12.2	9.2	6.0	3.0		E
25,000	16.5	14.1	11.5	9.0	7.0	4.7	2.0		R
20,000	13.0	11.1	9.2	7.4	5.5	3.7	1.5		G
15,000	10.0	8.6	7.0	5.7	4.0	3.9	1.4		E
10,000	8.0	6.8	5.6	4.5	3.4	2.3	1.1		N
5,000	6.5	5.5	4.6	3.7	2.8	1.8	1.0		C
S. L.	5.5	4.7	3.9	3.1	2.3	1.5	0.7		Y

GROUP II (4 G-1 Cylinders)
Co-pilot, Bombardier and Top Gunner

Gage Pres.									
	400	350	300	250	200	150	100	50	
Alt. Ft.									
40,000	33.2	28.6	23.6	19.0	14.2	9.6	4.6		E
35,000	23.6	20.2	16.8	13.4	10.2	6.8	3.4		M
30,000	17.2	14.8	12.2	9.8	7.4	5.0	2.4		E
25,000	13.2	11.2	9.2	7.4	5.6	3.8	1.8		R
20,000	10.4	9.0	7.4	6.0	4.4	3.0	1.4		G
15,000	8.0	6.8	5.6	4.6	3.4	2.4	1.2		E
10,000	6.4	5.4	4.6	3.6	2.8	1.8	0.8		N
5,000	5.2	4.4	3.6	3.0	2.2	1.4	0.8		C
S. L.	4.4	3.8	3.2	2.4	1.8	1.2	0.6		Y

Gage Pres.									
	400	350	300	250	200	150	100	50	
Alt. Ft.									
40,000	33.2	28.6	23.6	19.0	14.2	9.6	4.6		E
35,000	23.6	20.2	16.8	13.4	10.2	6.8	3.4		M
30,000	17.2	14.8	12.2	9.8	7.4	5.0	2.4		E
25,000	13.2	11.2	9.2	7.4	5.6	3.8	1.8		R
20,000	10.4	9.0	7.4	6.0	4.4	3.0	1.4		G
15,000	8.0	6.8	5.6	4.6	3.4	2.4	1.2		E
10,000	6.4	5.4	4.6	3.6	2.8	1.8	0.8		N
5,000	5.2	4.4	3.6	3.0	2.2	1.4	0.8		C
S. L.	4.4	3.8	3.2	2.4	1.8	1.2	0.6		Y

MAN HOURS OF AVAILABLE OXYGEN

BLACK FIGURES INDICATE AUTO-MIX "ON"

RED FIGURES INDICATE AUTO-MIX "OFF"

NOTE: Each turret cylinder, Type F-1, will supply one man for approximately 2 hours at 30,000 feet, 2½ hours at 25,000 feet, 3 hours at 20,000 feet.

AIRCO REGULATORS TYPE A-12

PIONEER REGULATORS TYPE A-12

GROUP III (6 G-1 Cylinders)
Bomb Bay, Radio Operator, Side Gunner,
Tail Gunner, and Ball Turret Filler

Gage Pres.	400	350	300	250	200	150	100	50	
Alt. Ft.									
40,000	49.8	42.8	35.4	28.4	21.4	14.4	7.0		E
35,000	35.4	30.4	25.0	20.2	15.2	10.2	5.0		M
30,000	25.8	22.2	18.2	15.6	11.0	7.4	2.8		E
25,000	19.8	16.8	13.8	11.2	8.4	5.6	2.8		R
20,000	15.6	13.6	11.0	8.8	6.6	4.4	2.2		G
15,000	12.0	10.4	8.6	6.8	5.2	3.4	1.6		E
10,000	9.6	8.2	6.8	5.4	4.2	2.8	1.4		N
5,000	7.8	6.6	5.6	4.2	3.4	2.2	1.2		C
S. L.	6.6	5.6	4.6	3.8	2.8	1.8	0.8		Y

Gage Pres.	400	350	300	250	200	150	100	50	
Alt. Ft.									
40,000	49.8	42.8	35.4	28.4	21.4	14.4	7.0		E
35,000	35.4	30.4	25.0	20.2	15.2	10.2	5.0		M
30,000	25.8	22.2	18.2	15.6	11.0	7.4	2.8		E
25,000	19.8	16.8	13.8	11.2	8.4	5.6	2.8		R
20,000	15.6	13.6	11.0	8.8	6.6	4.4	2.2		G
15,000	12.0	10.4	8.6	6.8	5.2	3.4	1.6		E
10,000	9.6	8.2	6.8	5.4	4.2	2.8	1.4		N
5,000	7.8	6.6	5.6	4.2	3.4	2.2	1.2		C
S. L.	6.6	5.6	4.6	3.8	2.8	1.8	0.8		Y

GROUP IV (3 G-1 Cylinders)
Radio Compartment (2 Outlets),
Side Gunner and Tail Gunner

Gage Pres.	400	350	300	250	200	150	100	50	
Alt. Ft.									
40,000	24.9	21.4	17.7	14.2	10.7	7.2	3.5		E
35,000	17.7	15.2	12.5	10.1	7.6	5.1	2.5		M
30,000	12.9	11.1	9.1	7.3	5.5	3.7	1.4		E
25,000	9.9	8.4	6.9	5.6	4.2	2.8	1.4		R
20,000	7.8	6.8	5.5	4.4	3.3	2.2	1.1		G
15,000	6.0	5.2	4.3	3.4	2.6	1.7	0.8		E
10,000	4.8	4.1	3.4	2.7	2.1	1.4	0.7		N
5,000	3.9	3.3	2.8	2.1	1.7	1.1	0.6		C
S. L.	3.3	2.8	2.3	1.9	1.4	0.9	0.4		Y

Gage Pres.	400	350	300	250	200	150	100	50	
Alt. Ft.									
40,000	24.9	21.4	17.7	14.2	10.7	7.2	3.5		E
35,000	17.7	15.2	12.5	10.1	7.6	5.1	2.5		M
30,000	12.9	11.1	9.1	7.3	5.5	3.7	1.8		E
25,000	9.9	8.4	6.9	5.6	4.2	2.8	1.4		R
20,000	7.8	6.8	5.4	4.4	3.3	2.2	1.1		G
15,000	6.0	5.2	4.3	3.4	2.6	1.7	0.8		E
10,000	4.8	4.1	3.4	2.7	2.1	1.4	0.7		N
5,000	3.9	3.3	2.8	2.1	1.7	1.1	0.6		C
S. L.	3.3	2.8	2.3	1.9	1.4	0.9	0.4		Y

10. COMMUNICATIONS EQUIPMENT

a. GENERAL. - A radio and interphone system provides for communications between crew members within the airplane; between the airplane and ground stations or other airplanes; reception of weather, range, and marker beacon signals; and ground and interphone identification.

b. INTERPHONE SYSTEM. - Interphone jack boxes are installed at 11 locations in the airplane. With any selector switch in "CALL" position, that station may be heard at all other stations regardless of the position of their selector switches. With all switches adjusted to "INTER," any station may be heard at all other stations. Any station may listen to the liaison, command, or radio compass receiver by adjusting the selector switch to those positions. Any station can modulate the command radio transmitter; however, modulation of the liaison transmitter is provided for pilot, copilot, navigator, and radio operator. All stations are provided with throat microphones, which,

with the exception of those for the pilot and copilot, are controlled by "PUSH-TO-TALK" switches on the cords. They are connected to the jack boxes by extension cords.

c. OTHER COMMUNICATIONS EQUIPMENT. Instruction for operating other communication equipment will be found in the section covering the compartment in which the equipment is located.

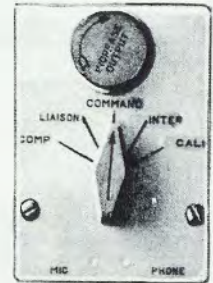

Figure 18
Interphone
Jack Box

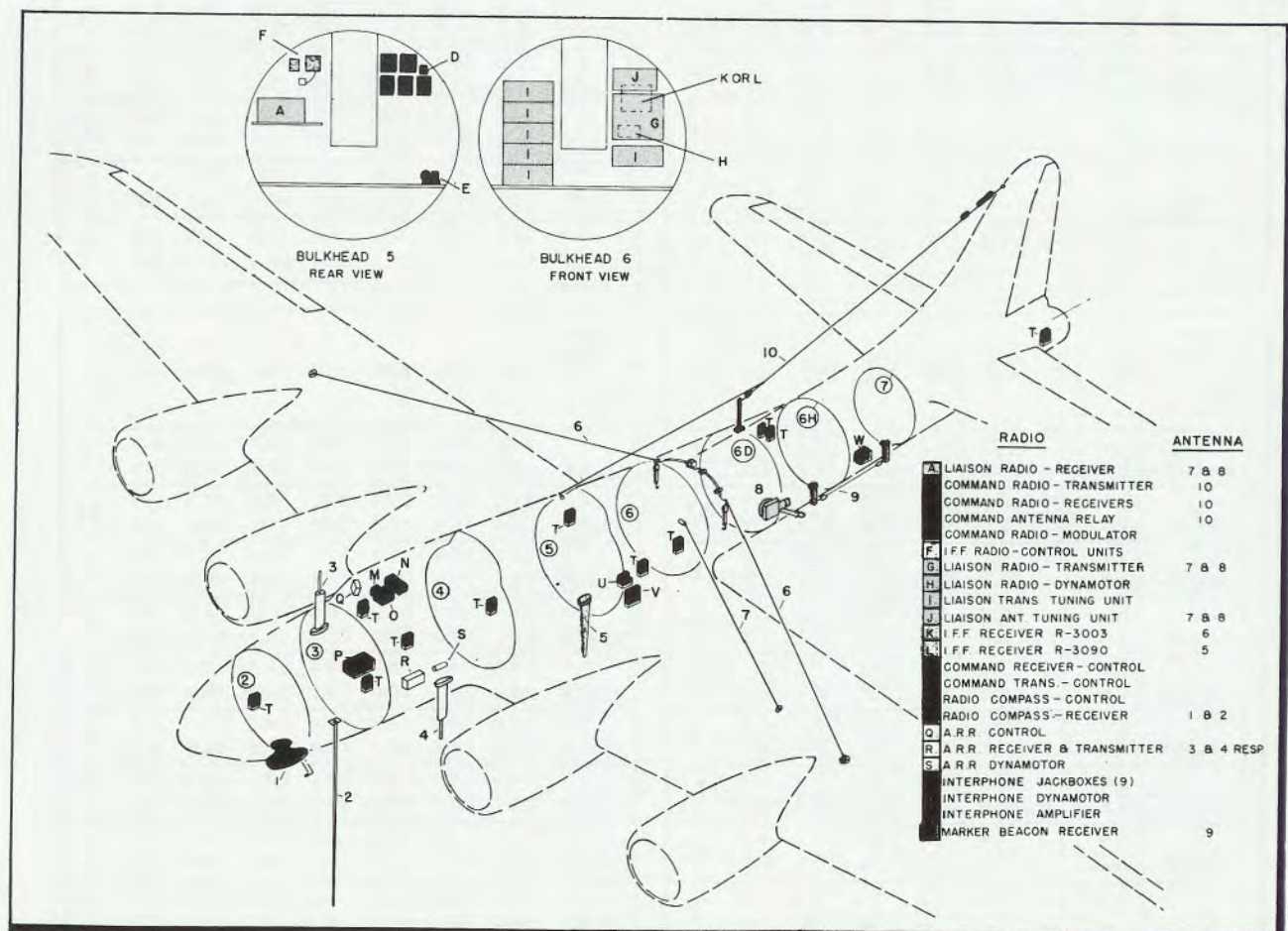
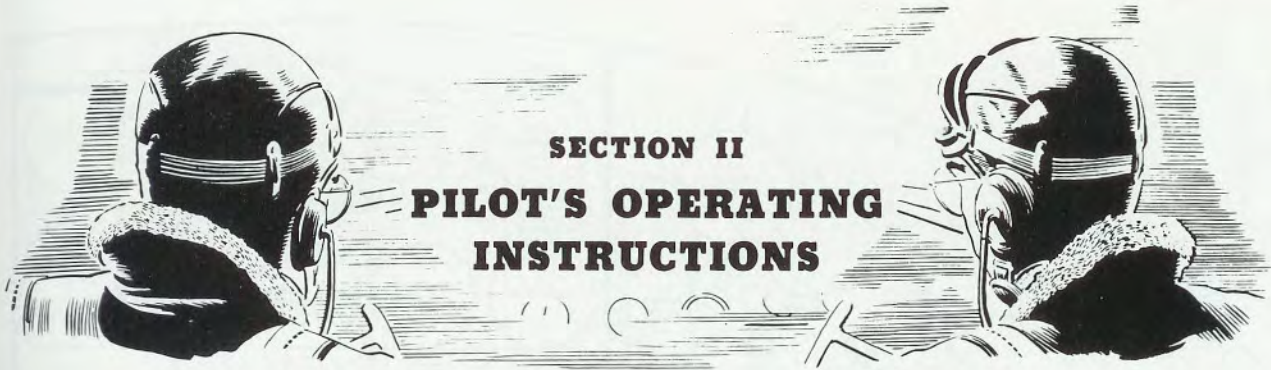











Figure 19 - Communications Equipment



SECTION II
PILOT'S OPERATING
INSTRUCTIONS

1. RESTRICTIONS

 <p style="text-align: center;">DON'T lower flaps at speeds in excess of 147 mph!</p>	 <p style="text-align: center;">DON'T dive in excess of 270 mph (with modified elevators).</p>	<p>WARNING</p> <p>Some airplanes are restricted to 220-mph maximum diving speed, pending modification of the elevators. See warning placard in airplane.</p>	 <p style="text-align: center;">DON'T exceed 46 inches Hg manifold pressure!</p>
 <p style="text-align: center;">DON'T exceed 30 inches Hg below 2100 rpm!</p>	 <p style="text-align: center;">DON'T stall the airplane! (except for training purposes.)</p>	 <p style="text-align: center;">DON'T spin!</p>	 <p style="text-align: center;">DON'T roll!</p>
 <p style="text-align: center;">DON'T loop!</p>	 <p style="text-align: center;">DON'T attempt inverted flight!</p>	 <p style="text-align: center;">DON'T fly the airplane at maximum gross weight (64,500 pounds) UNLESS auxiliary wing tanks are full!</p>	<p>CAUTION</p> <p>All power settings given in this section are for use with 100 octane fuel only. See appendix III for restrictions to be observed when using 91 octane fuel.</p>

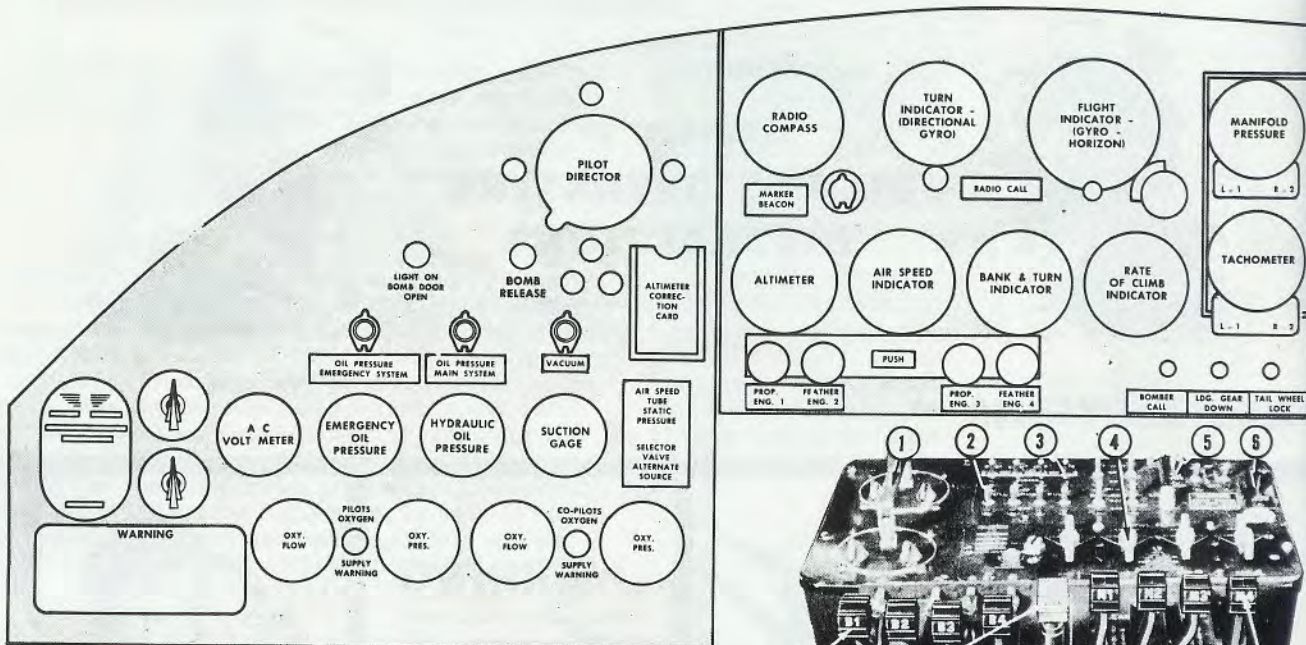

2. OPERATIONAL EQUIPMENT

a. CENTRAL CONTROL PANEL AND PEDESTAL.

(1) WING FLAP AND LANDING GEAR CONTROLS. - The wing flap motor is controlled by a toggle switch. The time required to lower the flaps at 147 mph is between 15 and 30 seconds.

WARNING

In returning the flap control switches from "DOWN" to "OFF," be sure the toggle switch is not allowed to snap to "UP," resulting in immediate retraction of the flaps.

(2) The main landing wheels and tail wheel are operated simultaneously by a toggle switch. A hinged guard prevents accidental moving of the switch to the "UP" position. Warning that the landing gear is not fully extended is given by a green indicator lamp failing to light, and by a horn which sounds if any throttle is closed.

(3) COWL FLAP VALVES. - Cowl flaps are operated by four valves, each valve controlling the flaps on one nacelle. The valve must be turned to "LOCKED" when the desired position of the flaps is reached. Slight "cracking" of the control valve will result in relatively slow travel of the flaps when close adjustment is desired.

(4) FUEL BOOST CONTROLS. - The fuel boost pumps, operated by four toggle switches, provide fuel

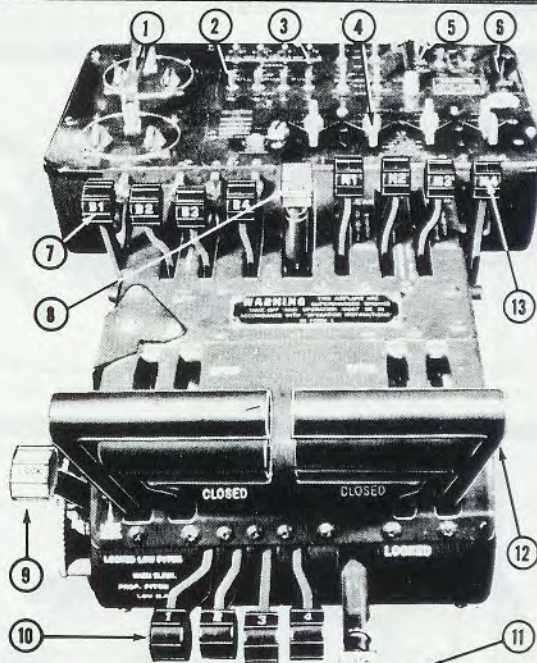

KEY TO FIGURE 21

- | | |
|---------------------------------|-----------------------------------|
| 1. IGNITION SWITCHES | 8. TURBO AND MIXTURE CONTROL LOCK |
| 2. FUEL BOOST PUMP SWITCHES | 9. THROTTLE CONTROL LOCK |
| 3. FUEL SHUT-OFF VALVE SWITCHES | 10. PROPELLER PITCH CONTROLS |
| 4. COWL FLAP CONTROL VALVES | 11. PROPELLER PITCH CONTROL LOCK |
| 5. LANDING GEAR SWITCH | 12. THROTTLE CONTROLS |
| 6. WING FLAP SWITCH | 13. MIXTURE CONTROLS |
| 7. TURBO SUPERCHARGER CONTROLS | |

Figure 21 - Control Panel and Pedestal

pressure for starting engines and for maximum power, and also prevent vaporization in the lines to engine-driven pumps due to hot fuel or high altitudes. Booster pressure at the No. 3 nacelle fuel strainer also supplies fuel to the priming system.

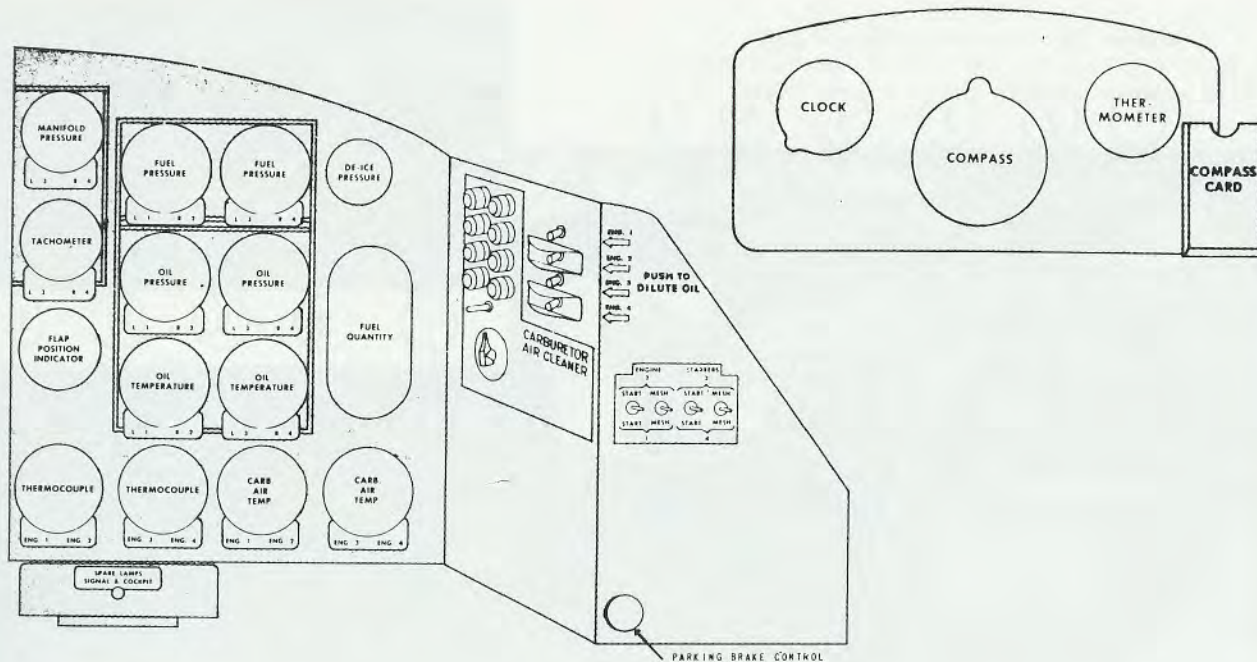

(5) FUEL SHUT-OFF VALVE SWITCHES. - Solenoid valves, operated by four toggle switches permit immediate shut-off of the fuel at the tank when necessary. Failure of electrical power causes the valves to "OPEN" allowing fuel to flow.

(6) IDENTIFICATION LIGHTS. - Two switches and a keying button permit signalling with any combination of the four lights.

(7) PROPELLER FEATHERING SWITCHES.

(a) Each propeller is feathered individually by one of the four red push button switches above the central control panel on the instrument panel. Pushing the switch in starts an electric pump in the nacelle which supplies hydraulic power for the feathering operation. When the propeller is fully feathered the pushbutton automatically releases, stopping the pump. To stop the operation before feathering is complete, pull out the switch button by hand.

(b) To unfeather a propeller, the push-button switch must be manually held in the closed position until unfeathering has been accomplished.

NOTE

When unfeathering a propeller on a cold engine, do not allow the engine speed to exceed minimum governing speed until oil pressure and oil temperature appear satisfactory. Turn off the ignition after feathering any propeller if the engine is to remain inoperative for any length of time. Do not operate more than one propeller feathering switch at a time, except in emergencies.

(8) TURBOSUPERCHARGER CONTROLS. - The supercharger regulators are operated by engine oil pressure. With warm oil in the engine the minimum time for operating the regulator control from the low boost to the high boost position should be 5 seconds. If the oil is somewhat cooler than normal engine temperatures, this should be extended to 15 seconds.

b. COPILOT'S AUXILIARY PANEL.

(1) CARBURETOR AIR FILTER CONTROLS.

(a) Carburetor air filter valve motors are controlled by one double-throw toggle switch located on the side of the auxiliary panel, forward of the copilot. When all the valves are "ON" permitting only filtered air to enter the supercharger intakes, four amber lamps are lighted. Four green lamps light when the control valves are "OFF," admitting only unfiltered air to the supercharger intakes. Any lamp failing to light indicates that the corresponding valve has not completed its travel to the full open or full closed position.

(b) Air filters should be "ON" for all ground operations and for dust conditions up to 8000 feet.

(c) Use of the filters above 8000 feet should be avoided, since operation above that altitude is accompanied by a rise in carburetor air inlet temperature, increasing the possibility of detonation. (This condition is aggravated by abnormally high outside air temperatures.) The turbo also has a tendency to overspeed. **IN ALL CASES, THE FILTERS MUST BE CLOSED ABOVE 15,000 FEET!** Failure to ob-

Figure 22 - Controls at Pilot's Left

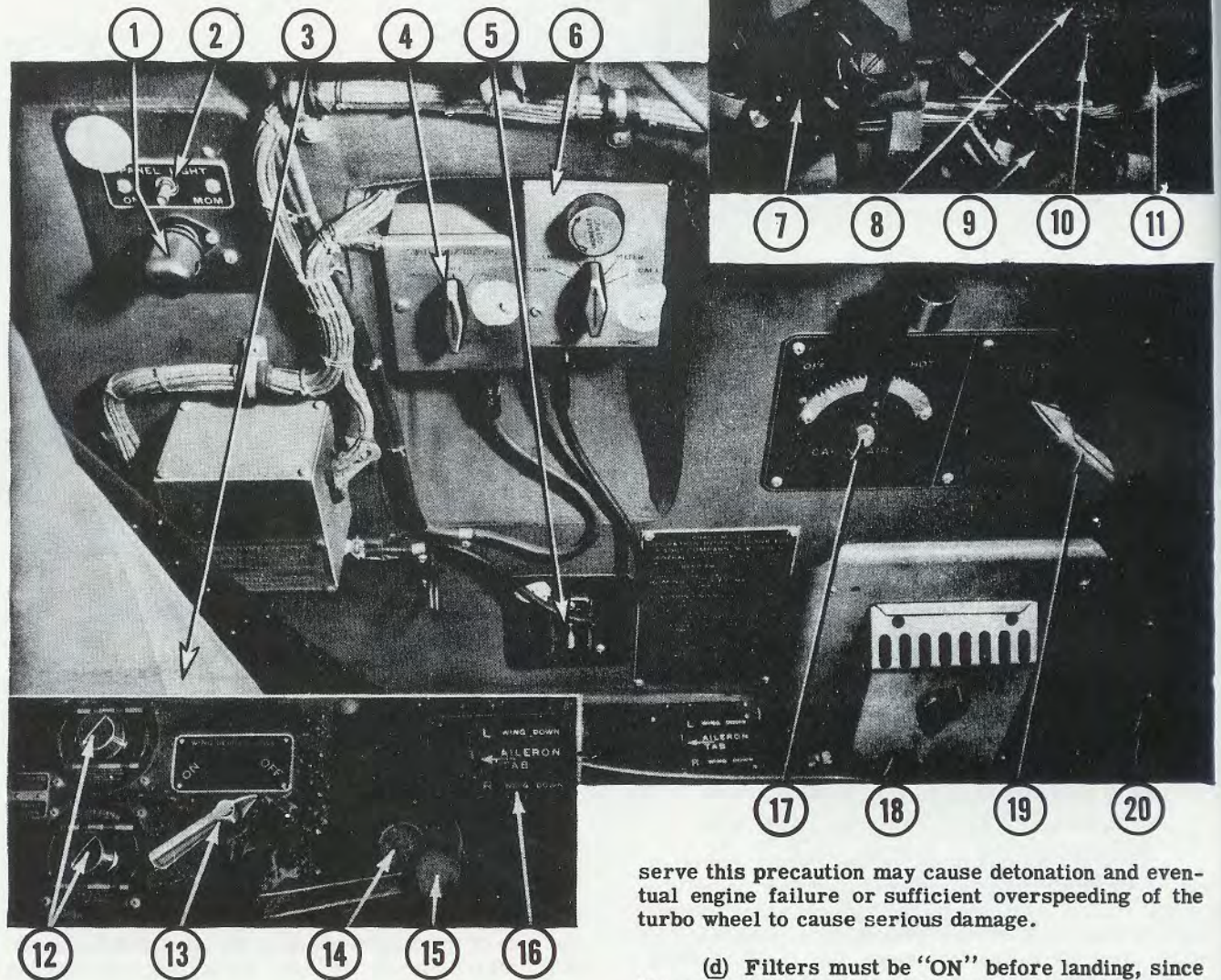

KEY TO FIGURE 22

- | | |
|---------------------------------------|-----------------------------------|
| 1. PANEL LIGHT | 12. PROPELLER ANTI-ICER RHEOSTATS |
| 2. PANEL LIGHT SWITCH | 13. SURFACE DE-ICER CONTROL |
| 3. PILOT'S SEAT | 14. AILERON TRIM TAB CONTROL |
| 4. FILTER SELECTOR SWITCH | 15. PILOT'S SEAT ADJUSTMENT LEVER |
| 5. PROPELLER ANTI-ICER SWITCH | 16. AILERON TRIM TAB INDICATOR |
| 6. INTERPHONE JACKBOX | 17. CABIN AIR CONTROL |
| 7. OXYGEN REGULATOR | 18. SUIT HEATER OUTLET |
| 8. WINDSHIELD WIPER CONTROLS | 19. VACUUM SELECTOR VALVE |
| 9. PORTABLE OXYGEN UNIT RECHARGER | 20. EMERGENCY BOMB RELEASE |
| 10. WINDSHIELD ANTI-ICER SWITCH | |
| 11. WINDSHIELD ANTI-ICER FLOW CONTROL | |

serve this precaution may cause detonation and eventual engine failure or sufficient overspeeding of the turbo wheel to cause serious damage.

(d) Filters must be "ON" before landing, since the supercharger control levers were adjusted for a maximum manifold pressure at take-off with the filters "ON." If emergency power is attempted with the filters "OFF," manifold pressures above the recommended maximum of 46 inches will be obtained.

(2) OIL DILUTION SWITCHES.

(a) Four momentary contact toggle switches on the side of the copilot's auxiliary panel operate solenoid valves in the corresponding nacelle, admitting fuel to the engine oil in line. This operation is performed AFTER an engine run, immediately prior to shutting it off.

(b) Do not dilute oil over 4 minutes. The supercharger controls should be operated continuously during this period to cause diluted oil to flow to the regulators. The propeller control should be moved

from extreme increase to extreme decrease rpm slowly several times to fill the propeller dome with diluted oil and prevent sluggish response of the propeller when starting the engine.

(3) STARTER SWITCHES. - Two START and two MESH switches control the engine starters. The START switch energizes the starter motor, rotating the inertia flywheel. The MESH switch engages the starter and engine jaws while the START switch is held on.

NOTE

Some airplanes have a "START-OFF-MESH" switch for each engine starter.

(4) PARKING BRAKE. - The pull handle at the bottom of the instrument panel sets the copilot's brake metering valves when the foot pedals are depressed. This utilizes the regular braking system; therefore, hydraulic system pressure must be available when the parking brake is required for any length of time. When necessary, set the parking brake handle and pump the system pressure to at least 400 pounds per square inch (minimum pressure for full braking control).

WARNING

Do not set parking brake while brake drums are hot.

(5) FUEL INDICATOR. - A liquidometer indicator, on the extreme right side of the instrument panel, shows the available fuel supply in any one of the six main fuel tanks. A six-position switch directly below the indicating dial, selects the tank to be checked.

(6) INSTRUMENT LIGHTING.

(a) Three spot lamps light the instrument panel and a fourth on the ceiling lights the compass panel. Two types of light are available: for flood lighting with visible fluorescent light, rotate the shutter to the left; for ultra-violet activation of the luminous paint on the instrument dials, rotate the shutter in the opposite direction approximately one-quarter turn.

(b) The spot lights are controlled by switches, two on the pilot's instrument panel, and one on the copilot's auxiliary panel. To operate, hold the switch in the "START" position for approximately 2 seconds; then, release the switch allowing it to spring back to the "ON" position.

c. CONTROLS AT PILOT'S LEFT.

(1) CABIN AIR CONTROL. - Heat and ventilation are controlled by a lever on the side wall. (See figure 11 for operation.)

CAUTION

Be sure the heater control is "OFF" or "COLD" for all starting and ground operations.

(2) VACUUM PUMP CONTROL. - The "GYRO INSTRUMENTS" selector valve on the side wall permits use of either vacuum pump for the gyro instruments, suction from the other pump being connected to the surface de-icer system. (See figure 13.)

(3) DE-ICER CONTROL. - The de-icer valve on the floor panel controls the operation of the surface de-icer shoes. In the "ON" position it starts the de-icer distributor and connects the exhaust pressure from both vacuum pumps, and the suction from one vacuum pump to the distributor valve. In the "OFF" position the distributor motor is turned off and the pressure from the vacuum pumps is bypassed overboard. Suction remains connected to the distributor valve in order to keep the de-icer shoes deflated.

(4) PROPELLER ANTI-ICER CONTROL. - A toggle switch on the side wall controls the two propeller anti-icer pumps. Two rheostats on the floor panel control the speed of the pump motors and may be used to turn the motors off if desired. Normally the rheostats should be left adjusted to a predetermined rate of flow and the pump motors turned on or off by means of the toggle switch.

(5) WINDSHIELD WIPER AND ANTI-ICER. - Windshield wiper and anti-icer controls are on a panel at the pilot's left.

(a) A toggle switch controls the operation of the wiper motor, "OFF," "SLOW," or "FAST," and a circuit breaker is provided to protect motor in case of an overload.

(b) An "ON-OFF" switch controls the alcohol pump, and flow is regulated by a needle valve.

CAUTION

Do not operate wipers on dry glass!

(6) EMERGENCY BOMB RELEASE. - An emergency bomb release handle is at the pilot's left. Pulling the handle immediately releases bomb door latches, and continued pulling will release all bombs SALVO the instant the doors are fully open. Bomb bay fuel tanks may be dropped by the release handle.

d. PILOT'S CONTROL PANEL.

(1) ALARM BELL CONTROL. - A toggle switch operates three alarm bells: one under the navigator's table, one above the radio operator's table, and one in the tail wheel compartment inside the dorsal fin.

(2) PHONE CALL. - Another toggle switch operates four amber phone call signal lamps: three ad-

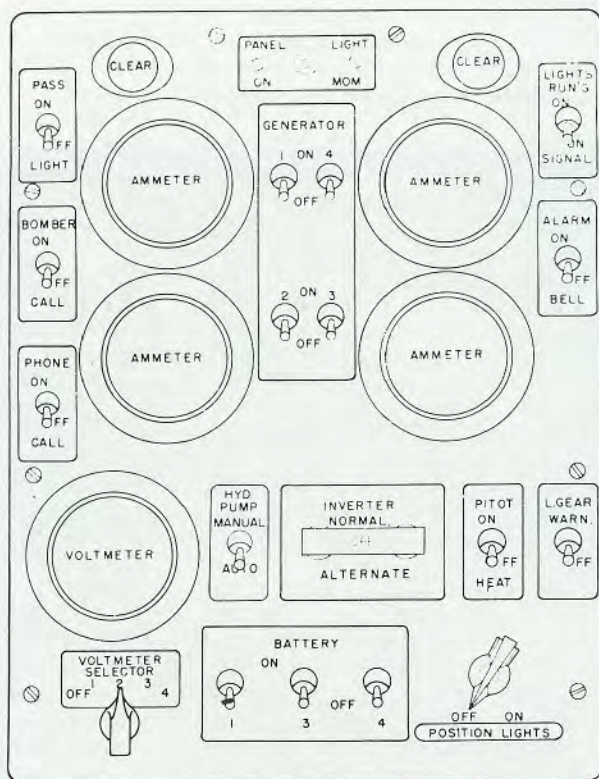

Figure 23 - Pilot's Control Panel

adjacent to the alarm bells, and the fourth at the tail gunner's right.

(3) **BOMBARDIER CALL.** - A toggle switch on the pilot's control panel operates an amber call lamp on the bombardier's control panel; and a toggle switch on the bombardier's panel operates an amber call lamp on the pilot's instrument panel.

(4) **LANDING GEAR WARNING HORN RESET.** - A switch on the control panel permits the silencing of the landing gear warning horn when it is desired to continue flight with one or more throttles closed. Operation of this switch does not prevent repetition of the warning for subsequent closing of any throttle while the landing gear is up. The switch is reset when the throttles are opened.

(5) **INVERTER SWITCH.** - A double-throw switch selects which of two inverters is to be used: in "NORMAL" position the left inverter is on; in "ALTERNATE" position the right inverter is on.

(6) **HYDRAULIC PUMP SWITCH.** - With this switch in the "AUTO" position, pressure is automatically regulated between 600 and 800 pounds. In case of failure of the automatic pressure, cut-out pressure may be maintained by holding the switch in the "MANUAL" position.

WARNING

In case of leakage stop the pump to prevent loss of fluid. Remove switch fuse at station 4 fuse panel or disconnect receptacle at switch. In some airplanes the hydraulic pump is controlled by an "ON-OFF" switch.

(7) **CARBURETOR ANTI-ICER.**

(a) Carburetor icing may occur in outside air temperatures up to 50°F (10°C), with humidity greater than 50 percent. Ice formation in the carburetor adaptor or at the fuel nozzle, indicated by engine roughness and a drop in manifold pressure, may be eliminated by moving the intercooler shutters to "HOT," or by setting the turbos "FULL ON" and adjusting power with the throttles. Apply full power and climb above icing condition if possible. Below 15,000 feet the air filters may be opened to provide a further increase of carburetor air temperature.

WARNING

DO NOT EXCEED ALLOWABLE LIMITS FOR MANIFOLD PRESSURE, ENGINE RPM, AND CYLINDER HEAD TEMPERATURE.

(b) Some airplanes are equipped with carburetor anti-icers consisting of pumps controlled by toggle switches on the pilot's control panel. One supplies inboard engines; the other, outboard engines. Approximately 4 gallons of isopropyl alcohol per hour are sprayed into the pressure duct of each carburetor, the entire system sustaining a total of 2 hours operation. This equipment should be used as follows:

1. To start an engine after severe carburetor icing or engine stoppage.
2. To determine cause of power loss or engine roughness; if adjustment of engine controls and use of

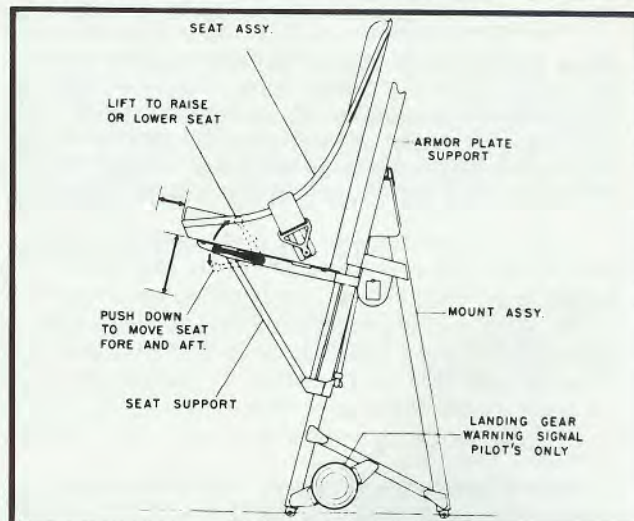

Figure 24 - Pilot's Seat Adjustment

alcohol system does not relieve condition, it can be assumed the trouble is not caused by icing.

3. To clear out engines quickly after a glide at low power through icing conditions.

4. To obtain full power under icing conditions.

5. As an alternate method of ice elimination if use of fuel turbo or carburetor air filter is prohibited.

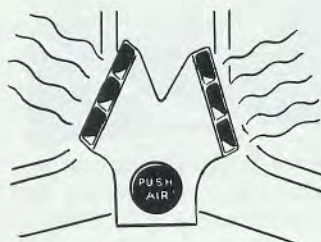

e. DEFROSTER CONTROL. - Hot air for defrosting the pilot's and copilot's windshields is controlled by a red button in the vee of the windshield.

f. TRIM TAB CONTROLS.

(1) Complete aileron tab travel requires about 3-3/4 turns of the knob located on the pilot's floor panel.

(2) Complete rudder tab travel requires about seven turns of the wheel located on the floor in front of the control pedestal.

(3) The elevator trim tab wheel on the left side of the control pedestal requires about six turns for complete travel. It has a friction brake to prevent creeping.

g. LOCKS.

(1) AILERON LOCK. - The aileron is locked in neutral position by a pin which is manually inserted in a hole in the left control column, holding the center spoke of that wheel in a padded slot. The pin is clipped to the pilot's control column when not in use.

(2) RUDDER AND ELEVATOR LOCK. - The rudder and elevator locking lever operates by cable control to place a pin in a socket on a segment at each of the control quadrants. The locking lever, which is recessed into the floor aft of the engine control pedestal, is locked in either the "UP" or "DOWN" position. The lever may be moved to the "UP" or "LOCKED" position, regardless of the attitude of the control surfaces. Under this condition, the control surfaces will automatically lock when the rudder is in the "NEUTRAL" position and the elevator is in the "DOWN" position.

(3) TAIL WHEEL LOCK. - The tail wheel locking lever operates a single cable to retrace a spring-loaded locking pin from a socket in the treadle. The

locking lever which is recessed into the floor aft of the control pedestal, latches in the "UP" position only and may be moved into the "DOWN" position regardless of the attitude of the tail wheel, which will lock when centered. To release the locking handle, press the knob on the end of it. A red signal light on the pilot's instrument panel is "OFF" when the tail wheel is locked.

h. AUTOMATIC FLIGHT CONTROL EQUIPMENT. The automatic flight control panel is located on the front of the control pedestal. To engage A.F.C.E.:

(1) Throw "ON" master and stabilizer switches.

(2) CAREFULLY TRIM AIRPLANE FOR STRAIGHT AND LEVEL FLIGHT.

(3) Turn "ON" tell-tale lights.

(4) After master and stabilizer switches have been "ON" for 10 minutes, throw "ON" PDI and servo switches.

(5) Center PDI by turning plane and resuming straight and level flight.

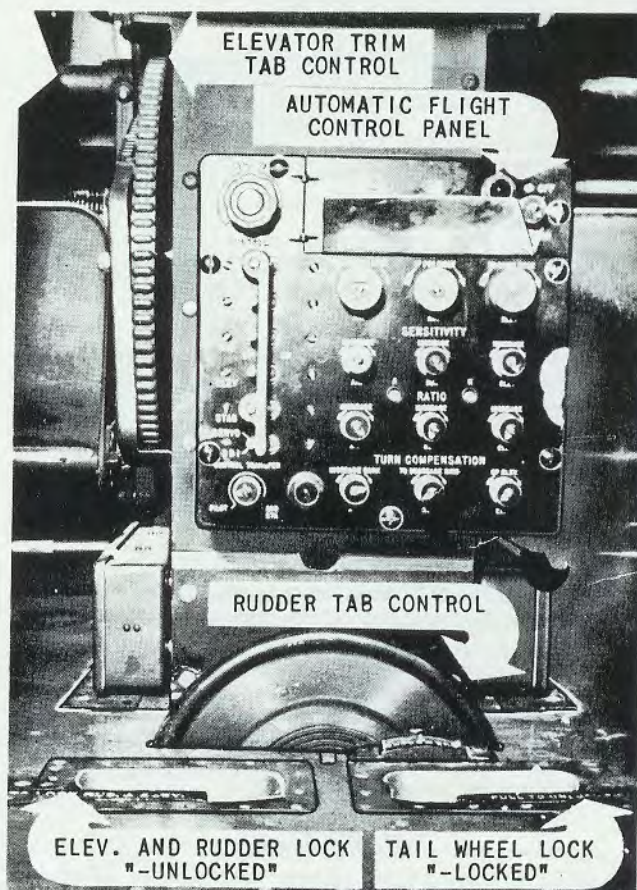

Figure 25 - Lower Control Pedestal

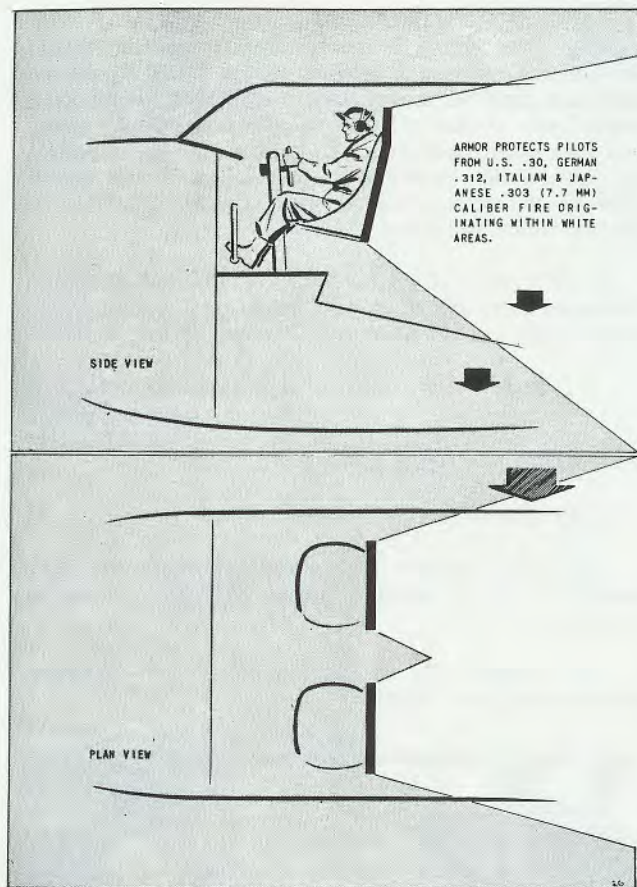

Figure 26 - Pilot's Armor Protection

(6) With PDI on "ZERO," adjust rudder centering knob until both rudder tell-tale lights go "OUT." Immediately throw rudder switch "ON."

(7) With wings level, adjust aileron centering knob until both aileron tell-tale lights go "OUT." Immediately throw aileron switch "ON."

(8) With airplane flying level, adjust elevator centering knob until both elevator tell-tale lights go "OUT." Immediately throw elevator switch "ON."

(9) Observe PDI, artificial horizon, and rate-of-climb or altimeter instruments. Then carefully retrim all centering knobs, until ship is flying as straight and level as possible, with PDI on "CENTER."

(10) With autopilot engaged, all course corrections must be made with turn control ONLY. Always turn knob with a slow steady movement.

WARNING

Do not engage A.F.C.E. motors until all "tell-tale" lights are off.

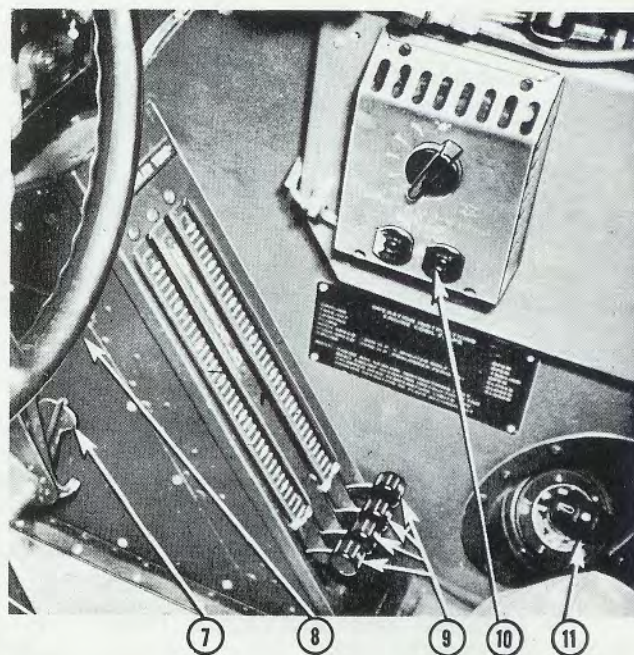
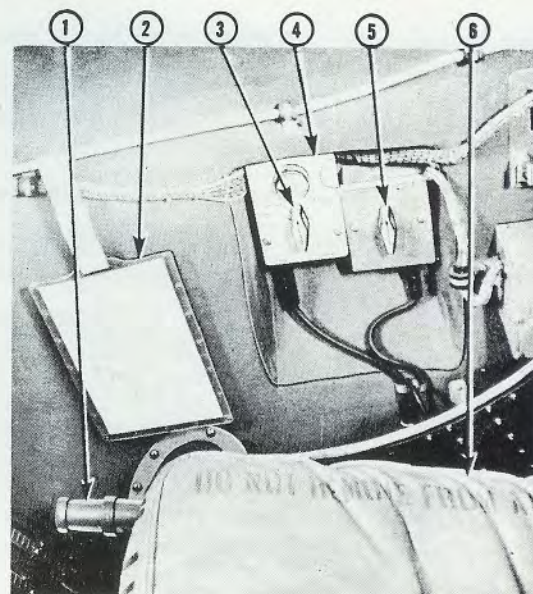

Figure 27 - Controls at Copilot's Right

KEY TO FIGURE 27

- | | |
|-------------------------------|----------------------------|
| 1. HYDRAULIC HAND PUMP | 6. COPILOT'S SEAT |
| 2. CHECK LIST | 7. RUDDER PEDAL ADJUSTMENT |
| 3. INTERPHONE SELECTOR SWITCH | 8. COPILOT'S CONTROL WHEEL |
| 4. INTERPHONE JACKBOX | 9. INTERCOOLER CONTROLS |
| 5. FILTER SELECTOR SWITCH | 10. SUIT HEATER OUTLET |
| | 11. ENGINE PRIMER |

l. CONTROLS AT COPILOT'S RIGHT.

(1) **PRIMER.** - The cylinder head primer has four positions corresponding to the four engines, and an "OFF" position. The primer handle is locked only in the "OFF" position. To operate, push the handle down, turn the valve to the engine position required, and then withdraw the handle and pump the charge to the cylinder.

IMPORTANT

Overpriming will result if the handle is left in the withdrawn position. Therefore, each priming operation must terminate with the handle returned to the locked position.

(2) **CARBURETOR TEMPERATURE CONTROLS.** The intercooler shutters are controlled from a stand in front of the copilot. Each cable is operated by a slide latching in any desired position. To release the latch, pull handle out.

(3) **HYDRAULIC HAND PUMP.** - The hydraulic hand pump is manually operated to furnish pressure in case of failure of the electric pump.

(4) **KEY CASE.** - A key case on the side wall contains two keys which fit all door locks in the airplane.

l. **RUDDER PEDAL ADJUSTMENT.** - Rudder pedal tilt may be varied to any of five positions by a locking pin and sector at the outside corner of each pedal.

k. PILOT'S COMMUNICATIONS CONTROLS.

(1) GENERAL.

(a) All communications equipment may be operated to some extent from the pilot's compartment. Receiver and transmitter frequency selection may be controlled with the exception of the liaison equipment which must have both its transmitter and receiver frequencies set by the radio operator.

CAUTION

For normal operation of all communications equipment, the filter selector switch should be set at "BOTH." To receive the radio range without possibility of voice interference, set the selector switch to "RANGE." To receive voice without range interference, set selector switch to "VOICE."

NOTE

The head set extension cord should be plugged into the filter selector control box as shown in figure 28 and not into the interphone jack-box or the receiver control box.

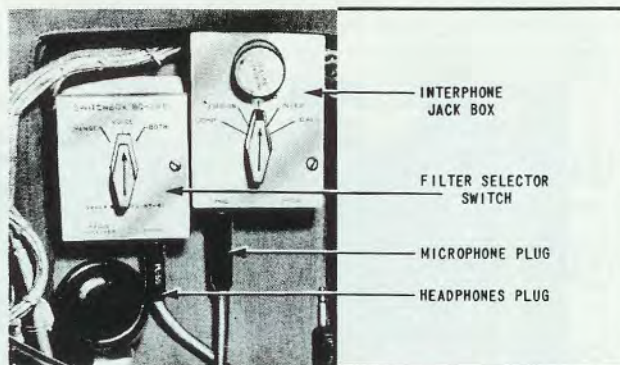

Figure 28 - Microphone and Headset Plugs

IMPORTANT

When the throat microphone is being used for either interphone or radio communication, it must be adjusted so that its two circular elements are held snugly against each side of the throat just above the "Adam's apple." **SPEAK SLOWLY, DISTINCTLY, AND IN A NORMAL TONE OF VOICE.** Shouting will seriously distort the voice signal.

(b) A possible means of limiting noise level in all radio equipment, caused by adverse conditions such as rain, snow, ice, or sand, is to direct the radio operator to proceed as follows:

1. Place the antenna change-over switch to the fixed antenna position.
2. Release approximately 50 feet of the trailing wire antenna.
3. Ground the trailing wire antenna post directly to the airplane structure (for instance, the metal support for the transmitter tuning units).

CAUTION

Do not extend retractable rod antenna at speeds greater than 240 mph.

(2) **INTERPHONE EQUIPMENT RC-36.** - An interphone jack box is provided for both pilot and copilot. Refer to section I, paragraph 10.

(3) **COMMAND SET SCR-274-N.** - The command set is designed for short-range operation and is used for communicating with nearby aircraft for tactical purposes and with ground stations for navigational and traffic control purposes.

(a) **RECEIVING.** - The interphone jack box (figure 22) switch must first be placed in the "COMMAND" position. The receiver control box (figure 29) is divided into three sections, each controlling the par-

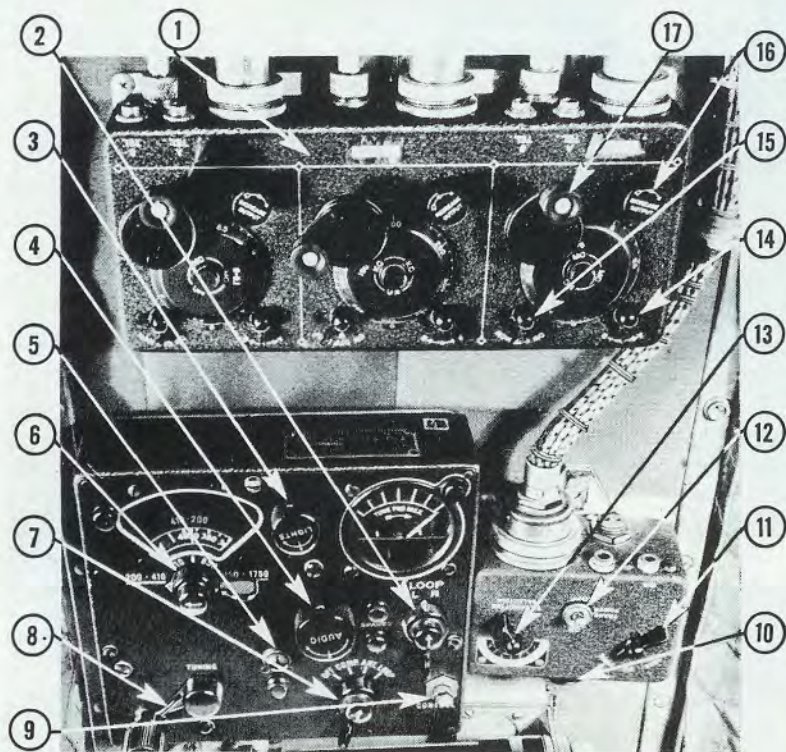

KEY TO FIGURE 29

1. COMMAND RECEIVER CONTROL UNIT
2. LOOP CONTROL SWITCH
3. LIGHT CONTROL SWITCH
4. VOLUME CONTROL
5. CONTROL INDICATOR LAMP
6. BAND SELECTOR KNOB
7. POWER SWITCH
8. TUNING CRANK
9. CONTROL PUSH BUTTON
10. TRANSMITTING KEY
11. TRANSMISSION SELECTOR SWITCH (TONE-CW-VOICE)
12. TRANSMITTER POWER SWITCH
13. CHANNEL SELECTOR SWITCH
14. A-B CHANNEL SWITCH
15. SIGNAL SELECTOR SWITCH
16. VOLUME CONTROL
17. TUNING CRANK

Figure 29 - Radio Controls, Pilot's Compartment Ceiling

tical receiver to which it is connected. Reception of a signal of a specific frequency as indicated on the dial is accomplished by the use of the section of the receiver control box which controls the particular receiver involved. The desired receiver is turned on and off by a switch in the left forward corner of the control box section used. This switch, in addition to having an "OFF" position, has two selective positions marked "CW" and "MCW," which indicate the type of signal which is to be received. The "A-B" switch should be left in the "A" position at all times and need not be turned off when the receivers are turned off.

NOTE

When tuning receiver for a definite frequency, always turn dial a little to each side of the frequency calibration mark to find the point where the signal is the strongest.

(b) TRANSMITTING.

1. Before transmitting, adjust radio receiver to the same frequency as the station with which you desire to talk, and listen in to be sure that the operator is not talking to someone else. If the station is transmitting, take advantage of the opportunity to more accurately set the airplane receiver on the assigned frequency, and when the other operator is finished, proceed with your transmission.

2. Throw the "OFF-ON" switch (figure 29) on the transmitter control box to the "ON" position. Select type of transmission desired with switch marked "TONE-CW-VOICE." With the switch in the "VOICE" position, the microphone from any interphone jack box switched to "COMMAND" position will be operative and voice will be transmitted when the push-to-talk button on the control wheel is pressed. With the switch turned to the "CW" position, a continuous wave, or unmodulated signal, will be transmitted and with the switch in the "TONE" position, a modulated tone signal is transmitted. Greatest effective range can be obtained on "CW." Range is most limited when operating on "VOICE."

3. On both the "CW" and "TONE" positions, the microphones are inoperative, and signalling by code is accomplished by a key which is located on the forward end of the transmitter control box.

NOTE

To reduce battery drain and to increase dynamotor life, the "TONE-CW-VOICE" switch should be left on "VOICE" unless continued use on "CW" or "TONE" is expected.

(4) RADIO COMPASS SCR-269.

(a) Set the interphone jack box switch (figure 22) to the "COMP" position, if aural reception of the

radio compass receiver is desired. If only visual indication is desired, the switch does not have to be set in the "COMP" position.

(b) The radio compass equipment is designed to perform the following functions:

1. Aural reception from the fixed antenna or from the rotatable loop. For signal reception during interference caused by precipitation static or proximity of signals, the loop will prove superior.

2. Aural-null directional indication of an incoming signal with the loop only in use.

3. Visual unidirectional indication of an incoming signal.

(c) The receiving unit is turned on or off by a switch on the face of the remote control box, which, in addition to having an "OFF" position, has three other positions: "COMP," "ANT," and "LOOP."

1. With the switch in the "COMP" position, both the rotatable loop and the fixed antenna are in use.

2. In the position marked "ANT" only the fixed antenna is in use.

3. With the switch turned to the "LOOP" position, only the rotatable loop is in use.

(d) If the green indicator on the face of the control box does not light, depress button marked "CONTROL" to establish control of the set at this unit. Select frequency band desired as indicated in kilocycles on the face of control box and tune by use of the crank to the desired frequency. The loop may be rotated to any position as indicated on the radio compass azimuth indicator by use of switch marked "LOOP L-R." (See figure 29.) This particular operation is possible only when operating on "LOOP" position of the selector switch. During periods of severe precipitation static, operate on "LOOP." For best aural reception rotate the loop by means of the "LOOP L-R" switch until a maximum signal is obtained. Proper volume may be obtained by use of knob marked "AUDIO."

(5) MARKER BEACON EQUIPMENT RC-43. - Since the operation of the marker beacon equipment

is fully automatic, no manual operation is necessary. As the ship passes over a fixed point from which a marker beacon signal is being transmitted, the signal is picked up by the receiver, causing the indicator to flash on, showing the pilot that he has passed over a marked beacon. The marker beacon equipment is simultaneously turned on when the radio compass is put into operation. The position of the interphone jack box switch does not affect the operation of the marker beacon equipment.

(6) LIAISON SET SCR-287.

(a) The liaison equipment is to be used for long-range communication. Limited control is available to the pilot. The type of reception and transmission desired must be forwarded to the radio operator, who will in turn put the radio equipment in operating condition.

(b) Set the interphone jack box switch in "LIAISON" position to receive or transmit with the liaison equipment.

(c) It is possible for all crew members to receive on this equipment, but only the pilot, copilot, and radio operator may transmit.

(7) RADIO SET SCR-535 (IFF). - The remote "OFF-ON" switch for this equipment is located on the top of the instrument panel hood. The two destroyer push-button switches are located to the left of the "OFF-ON" switch. The destroyer switches should be used only when it is contemplated abandoning the airplane over enemy territory. When both destroyer push buttons are pressed simultaneously, a detonator is set off in the receiver which is located in the radio compartment. The explosion of the detonator will destroy the receiver internally. No damage should be done to either the airplane or personnel at the time of destruction of the set, but bodily contact with the receiver at the time of detonation should be avoided.

NOTE

Regeneration adjustment of the IFF set must be made on the ground prior to flight in order to insure correct operation of the equipment.

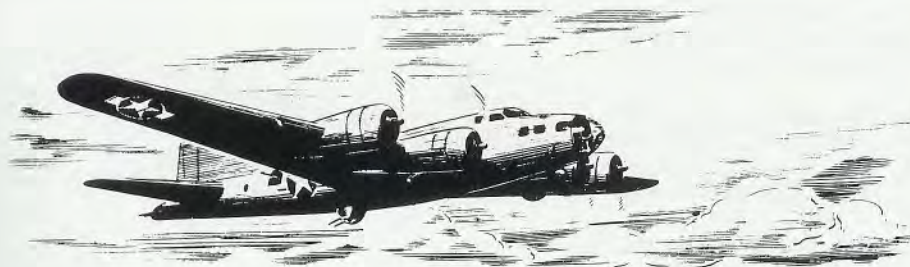

3. FLIGHT INSTRUCTIONS.

a. BEFORE ENTERING PILOTS' COMPARTMENT.

- (1) Check weight and balance data, form F, AN 01-1-40.
- (2) Check forms 1 and 1A and sign exceptional release if necessary.
- (3) Check flight engineer's report of preflight inspection.

b. ON ENTERING PILOTS' COMPARTMENT. - Check for all flights:

PILOT

COPILOT

- | | |
|---|--|
| <ol style="list-style-type: none">(1) Emergency ignition switch "ON."(2) Check each battery switch separately with either inverter on.(3) Master battery switches "ON."(4) Turn hydraulic pump switch "ON." If it is momentary "AUTO-MANUAL" type, it should remain in "AUTO" unless the pump fails to operate.(5) Landing gear control switch in neutral.(6) Flap control switch in neutral.(7) Have copilot set parking brake.(8) Ascertain free movement of flight control column, wheel and rudder pedals to the extremities of their operating range. | <ol style="list-style-type: none">(7) Set parking brake at command of pilot. |
|---|--|

c. SPECIAL CHECK FOR NIGHT FLIGHTS.

- | |
|---|
| <ol style="list-style-type: none">(1) Master battery switches "ON."(2) Turn control panel lights "ON."(3) Turn side control panel lights "ON."(4) Test operate the instrument panel lights.(5) Test operate the landing lights. |
|---|

WARNING

Do not permit lights to burn more than 5 seconds during test.

- (6) Test operate the identification lights.
- (7) Test operate the passing lights.
- (8) Test operate the position lights.



d. STARTING ENGINES.

PILOT

- (1) If the engines have stood for over 2 hours, have the propellers turned over three complete revolutions by hand. Be sure ignition switches are "OFF."
- (4) Cabin heat control in "OFF" or "COLD" position.
- (5) Move turbo controls to "OFF."
- (6) Post fire guard.
- (7) Open all fuel shut-off valves.
- (8) Crack throttles (approximately 1000 rpm).
- (9) Direct copilot to open carburetor air filters.
- (10) Set propeller controls for high rpm.
- (11) Turn magneto switch for engine affected to "BOTH."
- (13) Direct copilot to start engines. Recommended starting order is 1-2-3-4.

COPILOT

- (2) Order flight engineer to open manual shut-off valve and set selective check valve to "SERVICING" position.
 - (3) Check hydraulic pressure, both gages (600 to 800 pounds per square inch). Order flight engineer to close manual shut-off valve. Set selective check valve to "NORMAL" position.
 - (4) Open cowl flaps and return valves to "LOCKED" position.
 - (5) Fuel transfer valves and pump switch should be "OFF." Have flight engineer check them.
 - (6) Set fire extinguisher selector valve (if installed) to engine being started.
 - (7) Move intercooler controls to "COLD."
 - (8) Turn carburetor air filters "ON" when directed by pilot.
 - (9) Move mixture controls to "ENGINE OFF."
 - (10) Set primer to "OFF" position.
 - (11) Start No. 3 fuel booster pump for primer pressure. It should be 6 to 8 pounds per square inch.
 - (12) Start fuel booster pump for engine affected.
 - (13) Start engines when directed by pilot.
- (a) OLD-TYPE STARTER.
1. Move starter switch of engine affected to "START" position and hold for approximately 30 seconds.
 2. While starter switch is in "START" position, unlock primer, set to engine affected, and expel air from line by pumping until a solid charge of fuel is obtained.
 3. When directed by pilot, move starter switch to "MESH" position.
- (b) NEW-TYPE STARTER.
1. Throw "START" switch to engine affected and energize for 12 seconds.

PILOT

- (14) When the engine fires, move the mixture control to "AUTOMATIC RICH."

CAUTION

Do not advance the throttles as lean mixture and backfire hazard will result.

- (18) If no oil pressure is indicated within 1/2 minute after starting, direct copilot to stop engine with mixture control. Cut ignition and investigate.
- (19) In case of fire in the exhaust system, run up the engine in an attempt to blow out the fire. If this fails, direct copilot to stop the engine.
- (20) Close cowl flaps if the fire is in nacelle 1 or 2.
- (21) If fire is not smothered by closing the cowl flaps, close fuel shut-off valve, stop booster pump, and direct copilot to pull fire extinguisher, both charges if necessary.
- (22) Before resuming operations after fire, be sure that CO₂ cylinders are replaced.

COPILOT

2. Throw "MESH" switch while "START" switch is held on.
- (14) When the starter is meshed, prime with quick strokes (to atomize the primer charge) until the engine fires.

- (15) If necessary to prevent engine from quitting due to lack of fuel, pump primer with several slow strokes.

CAUTION

Return primer to "OFF" position.

- (16) Shut off booster pump if fuel pressure from engine pump remains steady.
- (17) If engine stops, return mixture control to "ENGINE OFF" immediately, cut ignition switch and repeat the starting procedure.
- (18) After engine starts, check for indication of oil pressure. If no pressure is indicated within 1/2 minute, notify pilot; move mixture control to "ENGINE OFF" when directed by pilot.
- (19) When directed by pilot, stop engine by moving mixture control to "ENGINE OFF."
- (20) Close cowl flaps if the fire is in nacelle 3 or 4.
- (21) Pull fire extinguisher charges (if available) at command from pilot.

NOTE

If engine accessory cowling is not installed, it is unlikely that the fire can be extinguished by the CO₂ system. External fire extinguishers must, therefore, be used.



e. ENGINE WARM-UP.

PILOT

- (1) When oil temperature begins to rise and oil pressure is 50 pounds per square inch, open throttles 1000 to 1250 rpm.
- (2) When engines are thoroughly warmed, the rpm may be increased for instrument check.

COPILOT

- (1) Notify pilot when oil temperature begins to rise and oil pressure is 50 pounds per square inch.
- (2) Notify pilot when maximum temperature and pressure values are reached.

CAUTION

2500 rpm must not be maintained for more than 1/2 minute and the following values must not be exceeded:

Fuel pressure	16 lb/sq in.
Oil pressure	80 lb/ sq in.
Oil temperature	88°C (190.4°F)
Cylinder temperature	205°C (401°F)

f. EMERGENCY TAKE-OFF.

(1) If the airplane has been on the "alert," the engines will have been started, and will be warm and ready for take-off by the time the flight crew gets within the airplane. The pilot will proceed with a routine take-off, being careful not to exceed 46 inches Hg manifold pressure.

(2) If an emergency take-off is necessary with cold engines, due to the lack of a ground crew, the following procedure should be followed:

(a) Start engines, using oil dilution as soon as engines fire in order to get minimum oil pressure of 70 pounds per square inch.

(b) Fuel pressure should be at least 12 pounds per square inch.

(c) Set wing flaps for take-off, leave cowl flaps less than 1/3 open to expedite warm-up. Proceed with take-off. Do not exceed 46 inches Hg manifold pressure.

g. ENGINE AND ACCESSORIES GROUND TEST.

PILOT

- (1) Direct gunner to secure lower turret with guns pointing rearward.
- (2) Set altimeter.
- (3) A.F.C.E. switches "OFF," all knobs on control panel, "POINTERS-UP," turn control, "CENTERED."

COPILOT

- (1) See that all doors and hatches are closed.
- (2) Hydraulic pressure should be 600 to 800 pounds per square inch on each gage.
- (3) With ignition and battery switches "ON," hydraulic switch in "AUTO," warning and indicator lights should be:

Tail wheel unlocked - On (red)
Landing gear - On (green)
Hydraulic pressure: Service - Off.
Emergency - Off.
Vacuum - Off.

- (4) Set propeller controls for high rpm and lock.

- (4) Check all fuel quantities.

PILOT

- (5) Turn command radio on.
- (6) Flight controls unlocked. Move them to the limits of their ranges to insure free operation.
- (9) Contact control tower for clearance.
- (10) Signal ground crew to remove wheel chocks.
- (11) With mixture controls in the "AUTOMATIC RICH," check ignition at 1900 to 2000 rpm.

NOTE

The rpm drop should not exceed 100 when switching from two magnetos to one.

- (12) Check propeller governor at 1500 rpm by moving control to low rpm. When rpm decreases to approximately 1100, return control to high rpm position and lock.
- (13) Run up each engine individually and adjust supercharger regulator control stops for 46 inches Hg manifold pressure at full throttle and 2500 rpm.

IMPORTANT

This adjustment must be made as quickly as possible and must not exceed 1/2 minute for each engine.

- (14) Set trim tabs in neutral.
- (15) Check flight controls.

WARNING

Operate to full extent of their ranges to insure free and proper movement.

- (16) Close window.

COPILOT

- (5) Set intercooler controls to "COLD" unless icing conditions exist.
- (6) Cowl flaps should be open. Check visually.
- (7) Wing flaps up. Switch in neutral.
- (8) Tail wheel unlocked. Locking handle should be in up position.

- (11) Check the following during ignition check:

Fuel Pressure: Desired - 12 to 16 lb/sq in.
Maximum - 16 lb/sq in.
Minimum - 12 lb/sq in.

Oil Pressure: Desired - 75 lb/sq in.
80 lb/sq in.
70 lb/sq in.

Oil Temperature: Desired - 70°C (158°F)
Maximum - 88°C (190°F)
Minimum - 60°C (140°F)

Cylinder Temperature: 205°C (401°F)
Maximum

- (13) Notify pilot if any temperature or pressure reading is not satisfactory.

- (15) Turn all fuel boost pumps "ON."

- (16) Close window.

h. TAXYING.

PILOT

- (1) Inboard throttles may be locked for taxiing with outboard engines.

COPILOT

- (1) Notify pilot if:
 - Cylinder temperature exceeds 205°C (401°F).
 - Oil pressure exceeds 75 pounds per square inch or is less than 15 pounds per square inch for idling engines.
 - Oil inlet temperature exceeds 70°C (158°F).
 - Fuel pressure is over 16 pounds per square inch or under 12 pounds per square inch.
- (2) Lock tail wheel (warning lamps off) after airplane has taxied to take-off position.

i. TAKE-OFF.

PILOT

- (1) Refer to the Take-Off Chart, Appendix II.
- (2) Turn generator switches "ON."
- (3) Open throttles slowly to FULL THROTTLE (3 to 5 seconds). Hold three-point position until airplane leaves ground.
- (4) With a runaway turbo or propeller, follow the following instructions:
 - (a) THROTTLE BACK FIRST.
 - (b) Move turbo control to "OFF."
 - (c) If necessary, set propeller controls (figure 40-3) in "LOW RPM." There is small likelihood of a runaway turbo, but the danger is great if it occurs during a take-off. The pilot MUST be alert during the take-off to note immediately and correct any excessive manifold pressure.
- (5) When airplane is clear of the ground, direct copilot to retract the landing gear.
- (6) Accelerate to speed for cruising climb.

COPILOT

- (5) Retract landing gear at command from pilot.
- (6) Cylinder head temperatures must not exceed 260°C (500°F) (5 minutes maximum).
 - Oil pressure - desired - 80 lb/sq in.
 - Oil Temp - desired - 70°C (158°F)
 - Fuel Pressure - 12 to 16 lb/sq in.
- (7) Adjust intercooler control to "COLD" unless icing conditions prevail.

j. ENGINE FAILURE DURING TAKE-OFF.

PILOT

- (1) Failure of an engine during take-off may not be noticeable immediately except for a resultant swing. If, therefore, a swing develops, and there is room to close the throttles and pull up, this should be done.
- (2) If it is necessary to continue with the take-off, even though one engine has failed, hold the airplane straight by immediate application of rudder. Gain speed as rapidly as possible. See that the landing gear is up, or coming up, and feather the propeller of the dead engine. Re-trim as necessary.

COPILOT

- (1) Press proper propeller feathering switch when ordered by pilot.

k. CLIMB. (Refer to climb chart, Appendix II.)

PILOT

- (1) Reduce manifold pressure with supercharger controls.
- (2) Reduce rpm as required for climb.
- (3) Make a visual check of engines 1 and 2.
- (4) Adjust trim tabs as required.
- (5) Order copilot to set carburetor air filter switch to "FILTER OFF" at 8000 feet unless dust conditions are found above that altitude.

COPILOT

- (2) Adjust cowl flaps as required to maintain proper cylinder head temperature.
- (3) Make a visual check of engines 3 and 4.
- (5) When ordered by pilot, move switch to "FILTER OFF."

WARNING

Switch must never be left in the "FILTER ON" position above 15,000 feet.

l. LEVEL FLIGHT.

PILOT

- (1) Refer to Cruising Control Charts, Appendix II.
- (2) Use full throttle and set power with turbo regulators at all altitudes.

COPILOT

- (2) Set mixture controls to "AUTOMATIC LEAN," below 2100 rpm, 30 inches Hg manifold pressure.

CAUTION

Do not exceed 30 inches Hg manifold pressure below 2100 rpm.

CAUTION

Instantaneous load factors above the allowable can be reached very easily with rough elevator control movements. In turbulent air or in combat maneuvering, corrections should be made very smoothly.

PILOT

COPILOT

- (3) Adjust cowl flaps as required to maintain proper cylinder head temperatures.
- (4) Stop booster pumps until needed (which will be above 15,000 feet).
- (5) Begin flight performance log and made entries in Form I as required.

m. PROPELLER FEATHERING.

PILOT

COPILOT

(1) TO FEATHER A PROPELLER.

- (a) Notify copilot to stop engine affected.
- (b) Turn automatic flight control equipment switches "OFF."
- (c) Notify copilot to press proper feathering switch.
- (d) When propeller stops, turn proper ignition switch to "ENGINE OFF."
- (e) Close throttle.
- (f) Adjust trim tabs as required.
- (g) Turn automatic flight control equipment switches "ON."
- (h) If the engine is not to be restarted, order engine fuel transferred to other tanks as required.
- (i) When No. 2 engine is affected:

- 1. The glycol pump is inoperative. If cold air is not desired in the cabins, shut off heating and ventilating system by moving control handle fully aft.
- 2. When one vacuum pump is inoperative, (engine No. 2 or 3): Set vacuum pump selector ("GYRO INSTR.") valve to the other vacuum pump. (De-icer pressure will thus be reduced and de-icer vacuum will not be available. De-icer system will, therefore, operate inefficiently.)

(2) TO UNFEATHER A PROPELLER.

PILOT

COPILOT

- (a) Notify copilot which engine is to be restarted.
- (b) Turn automatic flight control equipment switches "OFF."

- (a) Set propeller control to "LOW" rpm.
- (b) Set intercooler control to "HOT" position.

PILOT

- (d) Crack proper throttle to 1000 rpm approximately.
- (e) Turn ignition switch to "BOTH."
- (f) Press proper feathering switch and hold it closed until engine speed reaches 1000 rpm.
- (g) Open throttle slowly to 1200 rpm.
- (h) Adjust trim tabs as desired.
- (i) Maintain 1200 rpm until notified by copilot that oil temperature is 70°C (158°F).
- (k) Synchronize manifold pressure and rpm with other engines.

CAUTION

Above 15,000 feet, power must be adjusted with turbo control - full throttles.

- (l) Adjust trim tabs as required.
- (m) Turn automatic flight control equipment switches "ON."

NOTE

When No. 2 propeller is unfeathered, the pilot may turn on the heating and ventilating system by moving the control to any position between one-half and fully forward.

II. GENERAL FLYING CHARACTERISTICS.

(1) GENERAL STABILITY.

(a) Increasing the power on the inboard engines causes the airplane to become slightly tail heavy, while a change of power on the outboard engines has no appreciable effect upon the trim.

(b) Closing the cowl flaps on the inboard engines causes a similar tail heaviness, but cowl flaps on the outboard engines have a negligible effect upon the trim.

(c) With the airplane properly trimmed for a landing with power off and flaps down, the pilot may apply power, throw the flap switch into the up position and go around with no change in trim tab setting

COPILOT

- (c) Close cowl flaps.
- (d) Start proper booster pump (if above 15,000 feet).
- (e) Check fuel quantity in proper tank.
- (f) When engine speed reaches 1000 rpm, move mixture control from "ENGINE OFF" to "AUTOMATIC RICH."
- (i) Notify pilot when oil temperature reaches 70°C (158°F).
- (j) When cylinder head temperature reaches 205°C (401°F), open cowl flaps as required for continuous operation.
- (k) Adjust intercooler control as required.

if a second approach is necessary. The flaps retract at a satisfactorily slow rate.

(2) TAKE-OFF. - During the take-off run, directional control should be maintained with rudder movement and throttles, differential throttling being done with the outboard engines as much as possible.

(3) CLIMB. - The airplane will require very little elevator trim and the elevator control pressure will build up rapidly as the climbing speed is reduced below normal.

(4) LEVEL FLIGHT. - In normal flight, turns can be made very smoothly with aileron control only. In instrument flight, the pilot should pay special attention

to holding the wing level, because the directional stability produces a noticeable turning tendency with one wing down.

WARNING

Care should be taken to avoid excessive use of the ailerons.

(5) ROUGH AIR OPERATION.

(a) The ailerons and rudder can be used without concern regarding excessive loads. It is almost impossible to damage the system without a deliberate attempt to do so. The forces required are small enough and the resultant responses large enough to maintain ample control of the airplane.

(b) In the case of the elevators, however, care must be exercised to assure smooth operation. In thunderstorms, squalls, and in or near extremely turbulent cumulous clouds, it is possible to develop excessive load factors with the elevators unless proper care is exercised.

(c) Operation in rough air should be made on the basis of holding constant the air speed with the elevator. Corrections for changes in altitude must be done with power, and for very rapidly rising air currents, it may be necessary to lower the landing gear.

(d) The airplane should not be dived through a cloud layer or through rough air at the maximum diving speed, nor should high-speed flight be attempted in rough air.

(6) OBTAINING MAXIMUM PERFORMANCE.

(a) The ceiling and climb at 35,000 feet are as great or greater than that of many fighter airplanes,

but the high speed is not as great as most fighters at normal altitudes; therefore, in order to outperform any enemy at 35,000 feet it will be necessary to out-climb him rather than to outdistance him.

(b) The increase of speed obtained by nosing the airplane down below the horizontal at rated power and at any high power condition is smaller than that obtained by fighters.

(c) In order to obtain maximum climb, the following technique should be used:

1. Maintain the proper climbing air speed (135 mph indicated).

2. In any emergency whatever, such as being pursued by the enemy, engine speed should be increased to 2500 rpm. The increase in rpm has a very appreciable effect on increasing propeller efficiency and rate of climb under conditions of climbing speed and high altitude, and, in addition, is not detrimental to the engine. The pilot should avoid the use of less than 2500 rpm when primarily interested in a high rate of climb at high altitudes.

3. 21,300 rpm has been determined to be the maximum operating turbo speed with a 5 percent over-speed allowance in emergencies. This would provide an emergency rating of 22,400 rpm. At any altitude greater than 30,000 feet and at any power obtained in automatic rich (with 2300 rpm or 2500 rpm, full throttle and turbos set for manifold pressures indicated in the following table), the exhaust gas temperatures are dropping rapidly and it is very unlikely that critical temperatures will be approached. The following tentatively determined manifold pressures will permit safe operation of the turbo under the given conditions:

Altitude	Manifold Pressures giving rated power at 2300 engine rpm and 21,300 turbo rpm		Manifold Pressures giving military power at 2500 engine rpm and 21,300 turbo rpm	
S.L.		39.0		47 in.
10,000	Rated Power	38.0	Military Power to 28,000 ft	46 in.
20,000		37.5		45 in.
30,000		37.0		41.5 in.
31,000		37.0		40.0 in.
32,000	Decreasing Power	36.5	These manifold pressures not allowable below 2300 rpm	38.5 in.
33,000		35.0		37.0 in.
34,000		33.5		35.0 in.
35,000		32.0		33.0 in.

NOTE

This table is based on the best present available information for maximum performance at 55,000-pound gross weight with carburetor air filters closed. All four turbo installations are not identical and hence, operation according to the above table will not result in identical turbo rpm for all engines.

4. The outboard engines have higher critical altitudes than the inboards by approximately 2000 to 3000 feet, and the inboard engine without boilers in the stack has a 1500-foot higher critical altitude than the engine with the boilers in the stack. The critical altitude of the outboard engines as far as limiting turbo rpm is concerned is 31,000 feet.

5. The above table actually applies only to the outboard engines. However, the differences between the inboard and outboard engines are covered by the margin of safety incorporated in the design of the turbo itself. Even though 22,400 rpm are allowable for military power operation, the right-hand column of the above table, is made for only 21,300 rpm.

(7) LANDING. - During the approach for landing very little change in elevator trim will be required. As the flaps are lowered the airplane becomes slightly tail heavy, but if it is trimmed slightly nose heavy at 147 mph with flaps up, it will be properly trimmed at 120 mph with flaps down. This is a satisfactory approach speed for gross weights below 50,000 pounds.

o. STALLS.

(1) Stalling characteristics are very satisfactory. Under no condition is there any sharp tendency to roll. Yawing is sufficiently suppressed to make any rolling at the stall of a very mild nature. Under all conditions a stall warning of several miles per hour is indicated by buffeting of the elevators.

(2) A pitching motion started by the elevators should be damped slowly. It will easily reduce the air speed well below the stall unless it is deliberately stopped.

(3) Full flap reduces the stalling speed about 15 mph for gross weights between 40,000 and 45,000 pounds, but full military power for the same loading conditions may reduce the stalling speed another 15 mph. Accidental or deliberate yawing will increase the stalling speed and increase any tendency to roll at the stall.

(4) The ailerons have a tendency to overbalance and reverse effectiveness at the stall. For example, if the left wing tends to drop at the stall and right aileron control is applied in an attempt to raise the left wing, the aileron operating forces will tend to decrease and cause full aileron deflection, but the response will be an increase in the roll to the left.

THE PROCEDURE IN RECOVERING FROM A STALL IS TO HOLD THE AILERONS NEUTRAL AND REFRAIN ENTIRELY FROM THEIR USE.

(5) Procedure for recovering from a stall is normal. The air speed for normal flight must first be regained by smooth operation of the elevators. This may put the airplane into a dive of 30 degrees or less. During the process of regaining air speed the rudder may be used to maintain laterally level flight for lateral control, but not until the air speed is regained. RECOVERY FROM THE DIVE MUST BE DONE IN A SMOOTH MANNER. Failure to make a smooth recovery may be a restalling of the airplane or a structural failure, both due to excessive load factors.

(6) Air-speed increase necessary to regain normal flight need not generally be more than 20 mph, and possibly, after practice, even less.

p. SPINS. - Inadvertent spinning is very unlikely, as stability and damping are very high. The airplane is not designed for spinning, and this maneuver should never be attempted.

q. DIVES. - Airplanes having modified elevators are limited to a maximum diving speed of 270 mph. Those airplanes whose elevators have not been modified are restricted to 220 mph maximum diving speed. See Warning Placard!

When diving, it is essential that the sensitivity of the elevator trim tab be kept constantly in mind. In making dives the elevator trim tabs must be set during the dive to maintain zero elevator force and must be used with great care during recovery.

r. PRECAUTIONS.

(1) MAXIMUM LOAD.

(a) B-17F airplanes, with modified landing gear and added chord-wise wing tip tanks, can be flown up to and including a gross weight of 64,500 pounds, with the following restrictions:

(b) At 64,500 pounds, the extra wing tip tanks must be full to obtain the effect of a relieving load on the wings in flight. Care must be exercised in taxiing avoiding rough ground. Take-offs, above a gross weight of 56,000 pounds may be made only on smooth fields or prepared runways. All pivot turns on one wheel, while taxiing, will be avoided.

(c) All B-17 type airplanes, equipped with extra wing tip chord-wise tanks, must be operated in accordance with (b) preceding, whenever the wing tip tanks are more than half full. Maximum permissible indicated air speed of B-17F airplanes, with extra wing tip tanks full, must be limited to 230 mph, when loaded to 64,500 pounds. Maximum maneuver permissible at 64,500 pounds; positive, 2.056; negative, 1.22; landing gear, 2.1.

(2) 1600-POUND BOMBS. -Some B-17F airplanes do not have a complete set of B-10 bomb shackles. 1600-pound bombs may be carried on the B-7 bomb shackle with these restrictions: If an airplane returns to base with 1600-pound bombs remaining on the racks,

s. APPROACH AND LANDING.

PILOT

- (1) Check center of gravity location for landing by means of the load adjuster.
- (2) Set altimeter to airport pressure altitude.
- (3) Notify radio operator to retract trailing antenna.
- (4) Turn automatic flight control equipment switches "OFF."
- (5) Direct copilot to adjust carburetor air to "FILTERS ON."
- (6) Move supercharger controls to full "ON," and propeller controls to "MAX. CRUISE." (2100 rpm).
- (7) Shut off de-icer system, if operating.
- (8) Order copilot to extend landing gear.
- (9) Check position of ball turret. Guns should be horizontal and pointing rearward.
- (10) Check hydraulic pressure; it should be 600 to 800 pounds per square inch on both gages.
- (11) Operate brakes. Hydraulic pressure should remain above 600 pounds per square inch. If main brakes are inoperative, prepare for emergency landing.
- (13) After speed has dropped below 147 mph, order copilot to lower wing flaps.
- (14) Adjust trim tabs as required.
- (15) Order copilot to call off air speed as required.

t. EMERGENCY TAKE-OFF IF LANDING IS NOT COMPLETED.

- (1) Open throttle wide.

CAUTION

Do not exceed 46 inches Hg manifold pressure.

they shall be released, in the safe condition, over water or the safest available area. The maximum permissible gross weight of the airplane will not be exceeded when carrying 1600-pound bombs. The pilot will guard against any severe maneuvering of airplane.

COPILOT

- (1) SELECTIVE CHECK VALVE MUST BE IN "NORMAL" position.
- (2) Set mixture controls in "AUTOMATIC RICH."
- (3) Set intercooler controls in "COLD," unless icing conditions exist.
- (4) Radio control tower or landing clearance.
- (5) When directed by pilot, throw carburetor air filter switch to "FILTER ON."
- (7) Check instruments.
- (8) Extend landing gear when directed by pilot (green signal light on).
- (9) Tail wheel should be locked (warning light off), locking lever flush with floor.
- (12) Check cowl flap valves. They must be in "LOCKED" position to guard against loss of oil supply through leaks in cowl flap actuating mechanisms.
- (13) Lower wing flaps when directed by pilot.
- (15) Call off air speeds when directed by pilot.

PILOT

- (2) Increase propeller speed to 2500 rpm.
- (3) Order copilot to raise landing gear and proceed with a normal take-off.
- (4) Order copilot to raise wing flaps after 500 feet altitude has been reached.

u. AFTER LANDING.

- (1) Move supercharger controls to "OFF" position.
- (2) Generator switches "OFF."
- (3) Order tail wheel unlocked after taxi speed has dropped below 30 mph.

v. STOPPING OF ENGINES.

- (1) If parking brakes are set, do not permit them to remain so for very long if the brake drums are hot.
- (2) Idle engines at approximately 800 rpm until cylinder temperature gages show temperatures are 170°C (338°F).
- (3) If the airplane is to remain outside overnight, or if an engine start is anticipated in temperatures below 0°C (32°F), order copilot to dilute oil for 4 minutes maximum: During oil dilution period, operate supercharger controls continuously full open to fully closed in cycles of approximately 10 seconds, to dilute oil in supercharger regulator system.
- (4) Set propeller controls in "HIGH RPM."
- (5) Before stopping engines, run at 1200 rpm for 30 seconds. Direct copilot to stop engines with mixture control.

w. BEFORE LEAVING THE PILOT'S COMPARTMENT.

Cut off all radio, de-icer, compartment, central control panel, and pilot's side control panel switches.

COPILOT

- (3) Raise landing gear when directed by pilot.
- (4) Raise wing flaps when directed by pilot.

- (1) Raise wing flaps.
- (2) Check cowl flaps "OPEN."
- (3) Unlock tail wheel when directed by pilot (lever as nearly vertical as possible).

- (3) Close oil dilution switches when ordered by pilot.

- (5) When directed by pilot, stop engines by moving mixture controls to "ENGINE OFF."

Complete Form 1.

Moor the airplane with the nose into the wind, set the parking brakes and lock the rudder and elevators. When attaching the mooring lines at the rope wells in the wings, allow approximately 16 inches slack in the line. This will prevent damage to the structure or loss of mooring control in case a tire goes flat with result and elevation of the opposite wing. Rudder and elevator locks will withstand gust loads from any direction up to 60 mph velocity.

SECTION III EMERGENCY INSTRUCTIONS

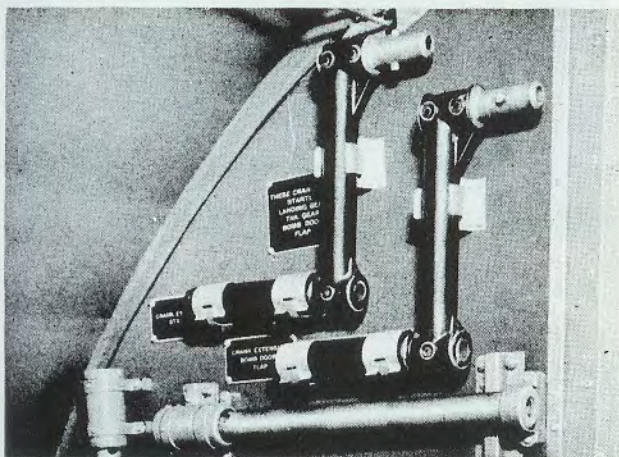
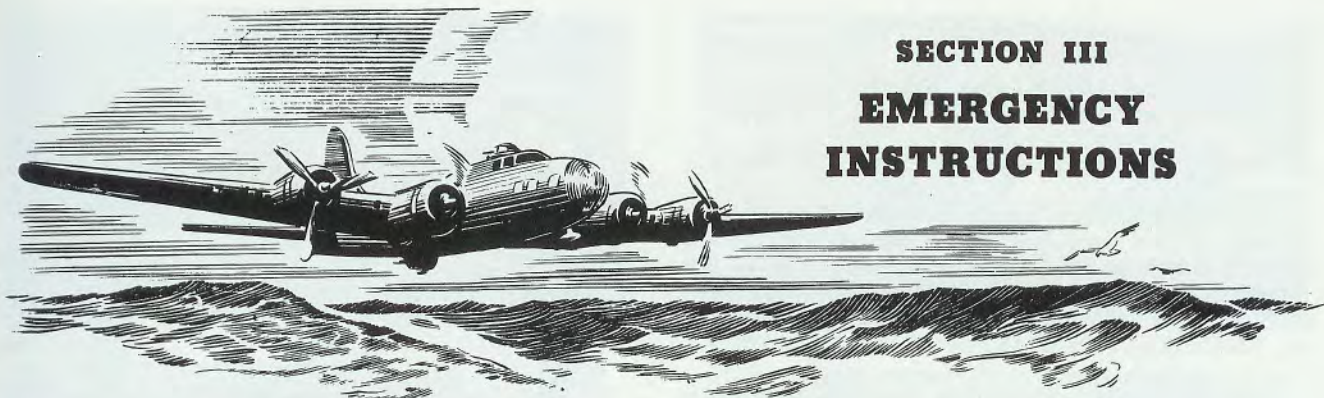

Figure 30 - Hand Cranks Stowed

1. HAND CRANKS.

Cranks for manual operation of landing gear, wing flaps, and bomb bay doors, and for hand starting of engines, are stowed on the aft bulkhead of the radio compartment. Crank extensions for use when operating engine starters, bomb doors, and wing flaps are stowed adjacent to the cranks.

2. EMERGENCY OPERATION OF LANDING GEAR.

Each main landing gear may be operated separately by means of a hand crank connection in the bomb bay, one to the left of the door in the forward bulkhead, and one to the right. To raise one of the landing wheels, insert the crank into the connection and rotate clockwise. Turn the crank counterclockwise to lower the wheel.

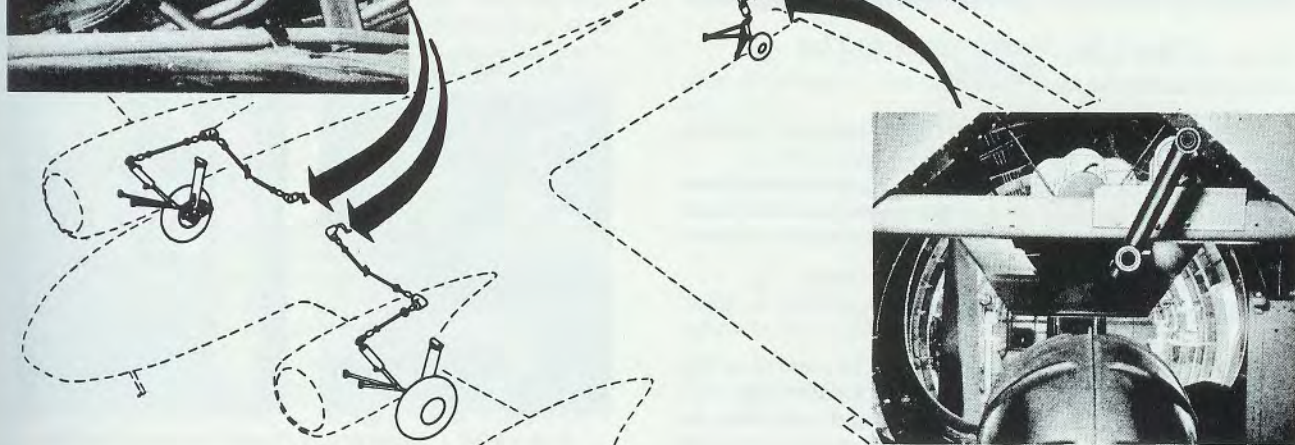
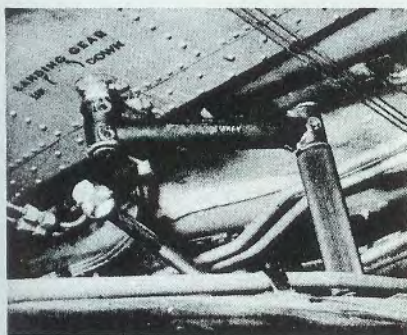

Figure 31 - Emergency Landing Gear Operation

DANGER

Be sure the landing gear electric switch is "OFF" before you attempt hand cranking.

3. EMERGENCY OPERATION OF THE TAIL WHEEL.

The crank used for manual operation of the landing wheels is also used for manual operation of the tail wheel. Insert the crank into the connection in the tail wheel compartment and rotate as desired.

4. EMERGENCY OPERATION OF WING FLAPS.

Lift the camera pit door in the floor of the radio compartment and insert the hand crank into the torque connection at the forward end of the pit. Rotate the crank clockwise to lower the flaps and counterclockwise to raise them.

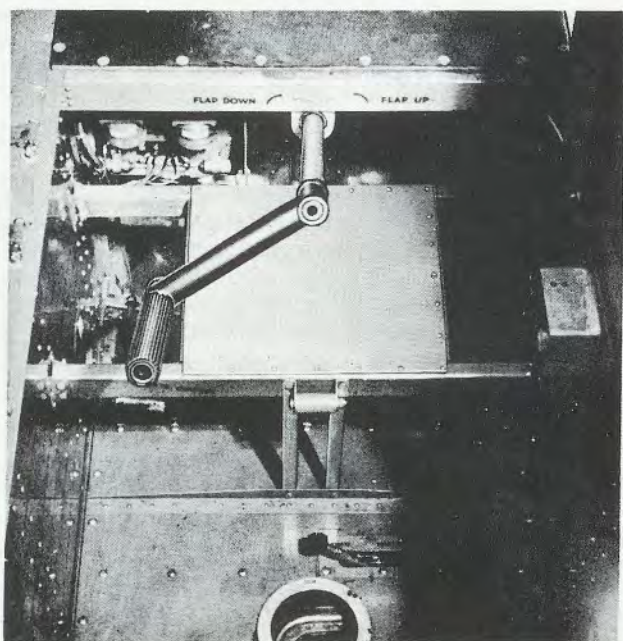

Figure 32 - Emergency Wing Flap Operation

5. EMERGENCY OPERATION OF BOMB BAY DOORS.

Insert the hand crank into the torque connection in the step at the forward end of the catwalk in the bomb bay and rotate clockwise to close the doors and counterclockwise to open them.

6. EMERGENCY BOMB RELEASE.

a. An emergency release handle is located at the pilot's left and another at the forward end of the catwalk in the bomb bay. Pull either handle through its full travel. The first portion of the stroke releases

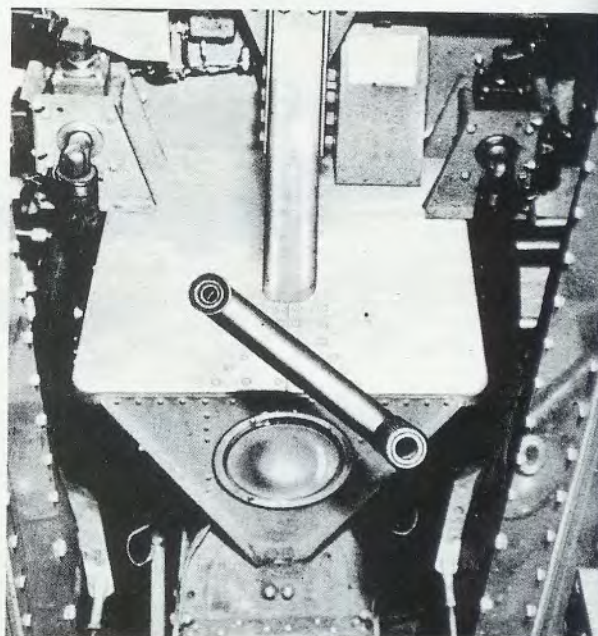

Figure 33 - Emergency Bomb Bay Door Operation

the bomb door latches, permitting the doors to open independently of the retracting screw, as shown in figure A. The latter portion of the stroke releases all external and internal bombs salvo and unarmed.

b. DOOR RETRACTION AFTER EMERGENCY RELEASE. - If the spring in the emergency release mechanism under the hinged door beneath the pilot's compartment floor has not entirely retrieved the linkage as shown in B, reset by pushing at the hinge of the link as shown in C. Operate the retracting screws electrically (or manually) to the fully extended position. This will engage the latches between the screws and door fittings as shown in D. The doors may now be retracted in the normal manner.

AT PILOT'S LEFT



IN BOMB BAY



Figure 34 - Emergency Bomb Release Handles

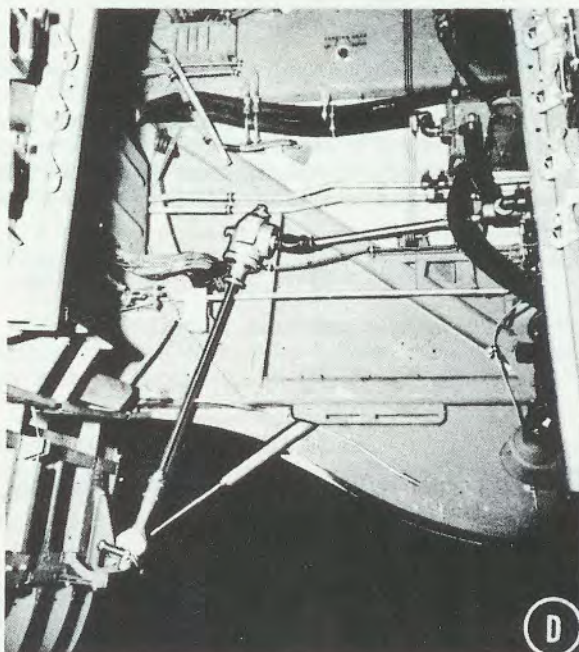
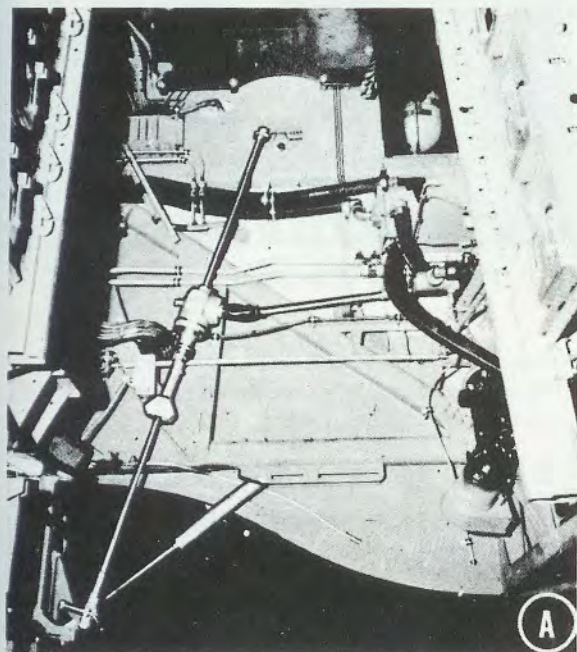
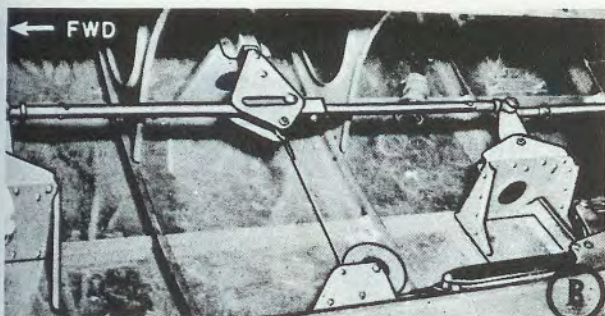

Figure 35 - Emergency Bomb Release Procedure

7. FIRE IN FLIGHT.

In case of engine or wing fires, open the emergency exits; signal stand by to abandon: one long ring (approximately 6 seconds). In case of a cabin fire, exits should NOT be open; signal stand by to abandon, exits closed: one long ring (approximately 6 seconds), and one short ring (approximately 2 seconds).

a. FUSELAGE FIRES.

(1) Three carbon dioxide fire extinguishers are located, one on the aft bulkhead of the navigator's compartment, one on the right rear bulkhead of the pilots' compartment, and one on the forward face of bulkhead of the radio compartment.

(a) To use; stand close to fire, raise horn, and direct gas to base of fire, holding on to rubber-insulated tubing.

WARNING

Do not grasp metal horn on top of cylinder. White discharge is "dry ice"; avoid frost bite.

(b) To shut off flow of gas, return horn to clip on side of cylinder. Extinguisher must be recharged after each use.

(2) Two carbon tetrachloride fire extinguishers are located one at the copilot's left, and one aft of the main entrance door.

(a) Stand as far as possible from the fire when using a carbon tetrachloride extinguisher; effective range is 20 to 30 feet.

(b) To operate, turn handle and pump plunger. Keep stream full and steady. To shut off, push handle in and turn until sealing plunger is depressed.

WARNING

When sprayed on a fire, carbon tetrachloride produces phosgene, an extremely poisonous gas, which can be harmful even in small amounts; and if inhaled in excessive quantities may prove fatal. Do not use in a confined area and do not stand near fire. OPEN WINDOWS AND VENTILATORS immediately after fire is extinguished.

b. ENGINE FIRES DURING FLIGHT.

(1) If caused by fuel or oil leakage:

(a) Close fuel shut-off valve of engine affected.

(b) Feather propeller immediately. This stops the pumping of oil to the flames, and should be done before so much oil is lost that the propeller cannot be feathered and additional damage is caused by wind-milling.

(c) Slow the air speed as much as possible.

(d) Close the cowl flaps.

(e) Pull CO₂ charge (if available).

CAUTION

Leave propeller feathered. Do not attempt to restart engine while hot.

(2) Fire in exhaust due to overrich mixture:

(a) Move mixture control to lean.

(b) Attempt to blow out fire by engine run-up.

(c) Close cowl flaps.

(d) Close fuel shut-off valve to engine affected.

(e) Pull CO₂ charge (if available).

8. EMERGENCY BRAKE OPERATION.

The emergency system operates the brake only. Pressure is applied through two hand-operated metering valves on the pilots' compartment ceiling; the left lever controls the left wheel, and the right lever controls the right wheel. If it is impossible to rebuild the pressure in the service system, use of the following procedure is recommended:

a. Manual shut-off valve "CLOSED."

b. Selective check valve "NORMAL."

c. Check pressure in emergency accumulator: 650 to 800 pounds.

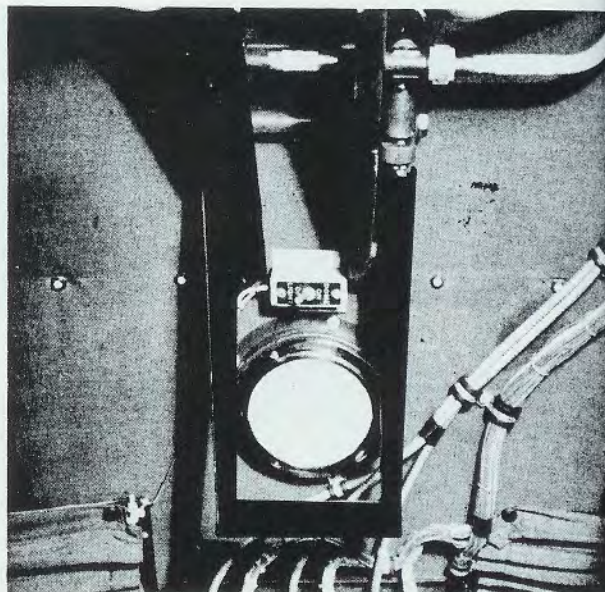

Figure 36 - Emergency Brake Handles

CAUTION

Do not attempt to raise the accumulator pressure with the hand pump.

d. Pilot: Operate throttle and rudder.

e. Copilot: Operate emergency brake control.

WARNING

DO NOT "PUMP" EMERGENCY BRAKES. The pressure supply is limited and repeated applications may result in complete loss of emergency braking control.

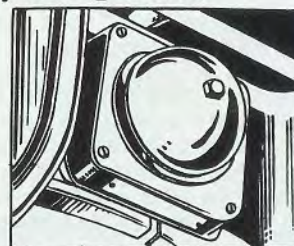

9. WARNING SIGNALS.

The pilot can communicate with the crew by means of the interphone system, phone call lamps, and the alarm bell system. For emergency purposes, the alarm bell should be used according to prearranged signals which are thoroughly understood by the crew. A toggle switch on the pilot's electrical control panel operates three bells located, one under the navigator's table, one on the wall above the radio operator's table, and one in the tail compartment above the tail wheel boot.

10. FIRST-AID KITS.

First-aid kits are located on the bomb-sight storage box in the navigator's compartment, on the wiring diagram box on the back of the copilot's seat, and on the bulkhead forward of the lower turret.

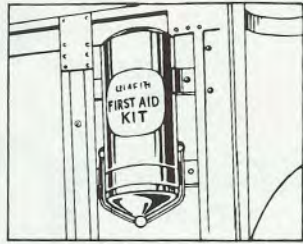

11. ABANDONING AIRPLANE IN FLIGHT.

a. ESCAPE DOORS AND HATCHES. - All doors and hatches are quickly releasable. The side gunner's windows slide forward to open. Bomb doors may be opened by either of two emergency release handles, one at the left of the pilot and the other at the forward end of the catwalk in the bomb bay.

b. SIGNAL.

(1) Stand by to abandon: one long ring (approximately 6 seconds).

(2) Abandon airplane: three short rings (approximately 2 seconds each).

c. SWITCHES. - The situation will determine whether fuel and electrical systems should be turned off prior to abandoning the airplane. Under normal conditions outside of combat zones, the master ignition switch battery switches and fuel shut-off valve switches should be turned off.

12. CRASH LANDING.

a. SIGNAL.

(1) Stand by for crash landing; by interphone.

(2) Abandon: four short rings (approximately 1/2 second each).

(3) Pilot should:

(a) Cut engines.

(b) Turn master switch "OFF."

(c) Turn battery switches "OFF."

(d) Turn fuel shut-off valve switches "OFF."

b. EGRESS.

(1) All crew members will take proper stations, remove parachutes, and fasten safety belts upon receiving interphone warning.

(2) At the signal to abandon, all crew members will leave the plane through the most practicable exit. (See figure 37.)

(3) In addition to the seven standard exits, the two side windows in the pilot's compartment are possible exits.

(4) In case some of the exits are blocked by fire, damage, or congestion, it may be best to make exit through a rupture in the fuselage, if any have occurred. Caution is required in this process to avoid fatal cuts from metal or broken glass.

(5) If there is imminent danger of fire, all personnel should disperse at least 50 feet from the airplane.

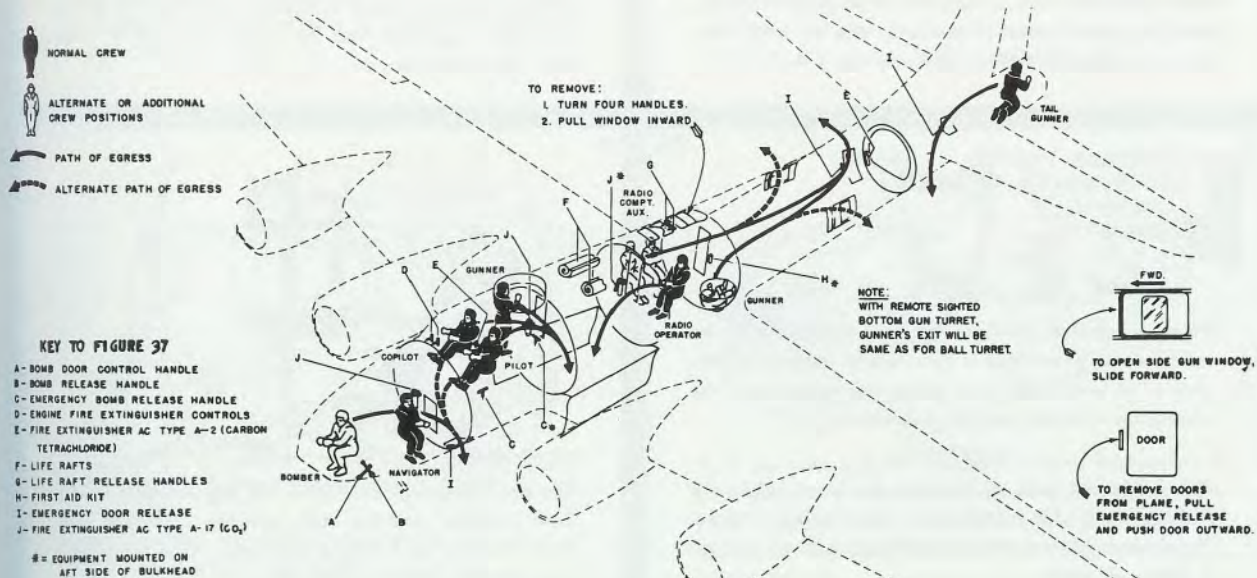
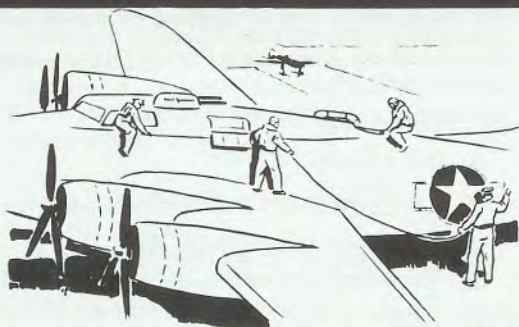

Figure 37 - Emergency Escape Routes

13. FORCED DESCENT AT SEA

1



As complete evacuation of the airplane should not take over 30 seconds, preflight practice drills should be participated in by all crews who are to make a flight over water, or whose operations are generally over water.

4

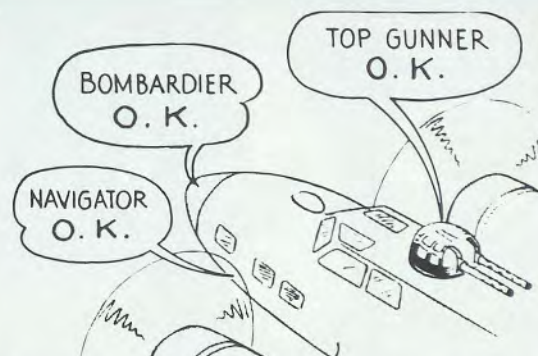

Each crew member will acknowledge the command over the interphone.

2

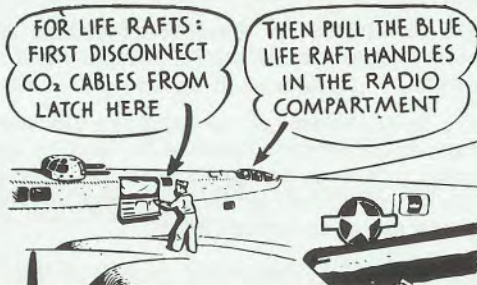

A complete and careful inspection of emergency equipment should be made before each long over water flight. Check life rafts, emergency kit bags (provisions), and emergency radio equipment. The kit bags and radio are stored aft of the radio compartment.

5



The bombardier after acknowledging the command, will jettison bombs, or bomb bay tanks if more than half full, and close the bomb bay doors. If there is not sufficient time to release the bombs and close the bomb bay doors, ascertain that the bombs are "SAFE" and leave the doors closed.

3



When it becomes evident that the airplane is to be forced down at sea due to lack of fuel, or that an altitude of at least 1,000 feet cannot be maintained, the pilot gives warning over the interphone.

WARNING!

This command must, if possible, be given while the fuel supply is still sufficient for 15 minutes of flight. The chances for a successful landing are much greater, if power is used.

6

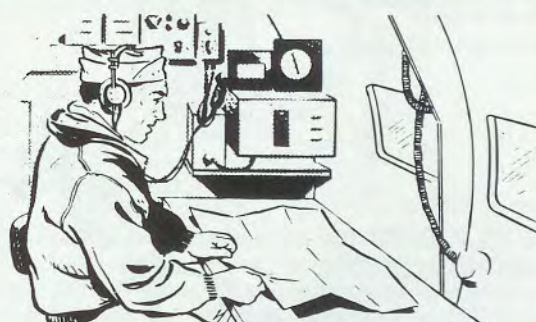

The navigator will determine the position and inform both the pilot and the radio operator. He will take with him the instruments necessary to make simple computation while on life rafts.

FORCED DESCENT AT SEA

7



The radio operator will jettison the hatch cover. Then, when directed by the pilot, he will send an appropriate distress signal and position. After completing this duty, he will bring the emergency radio set into the radio compartment.

10

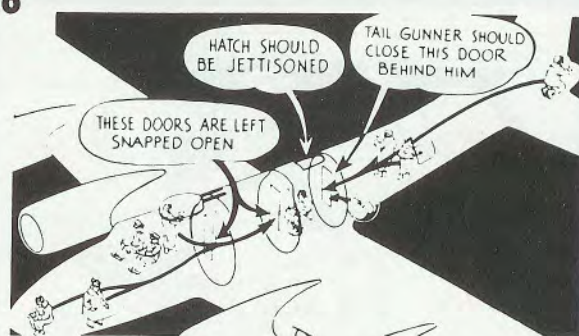

After completing his individual duties, each member goes to the radio compartment which is the crash station for all but the pilot and copilot.

8

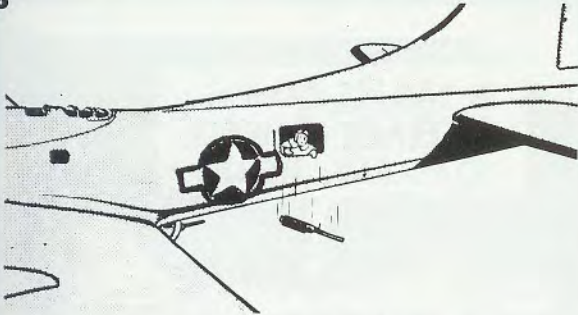

The side gunners will jettison the side guns as they make very dangerous battering rams. If there are no side gunners, this duty should be given to other crew members before flight.

11

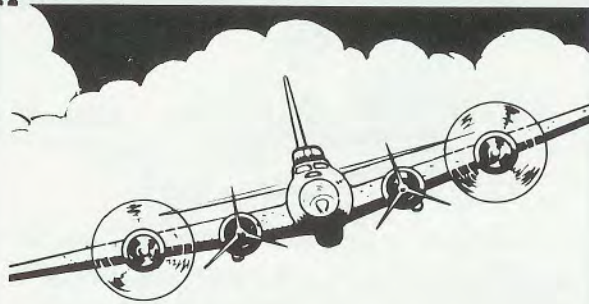

The pilot will direct the copilot to cut the two inboard engines, if the two outboard engines are functioning satisfactorily, and to feather their propellers.

9

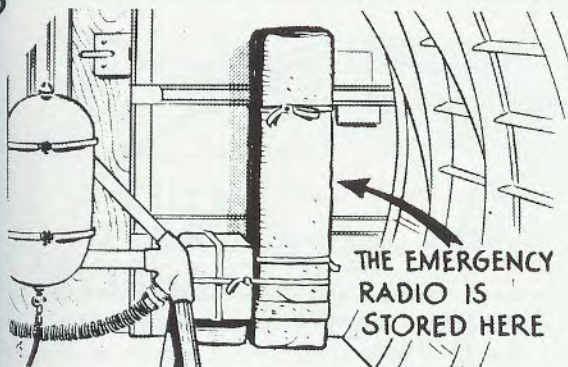

A crew member appointed before flight will take the emergency kit bags to the radio compartment.

12

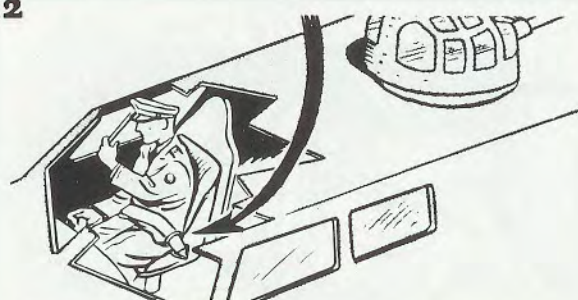

Both the pilot and the copilot will strap themselves in their seats. If the side windows are to be used as exits, slide windows open, then close, insuring freedom of operation. Leave them closed until after the impact. **CAUTION!** Place axe handy in event of jamming.

FORCED DESCENT AT SEA

13



Be sure all emergency equipment is in the radio compartment. Throw overboard any equipment that might come loose.

16

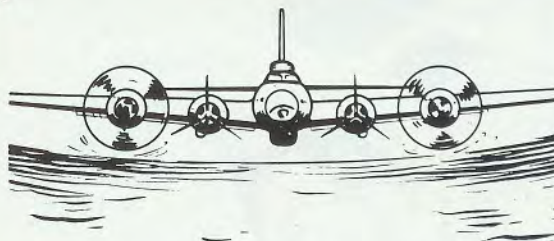

The pilot should attempt to set the airplane down in a trough, which is usually cross wind. The two outboard engines are used for control and to flatten the approach. The landing gear should be up, the flaps lowered medium, and the ignition switches cut a foot or so above the water.

14



Remove cushions from seats for head protection and take crash positions. Do not take a position in the center of the compartment as ball turret upper structure makes this unsafe. Brace head against solid structure, if possible. Do not leave these positions until plane has come to rest as there will probably be more than one shock.

17

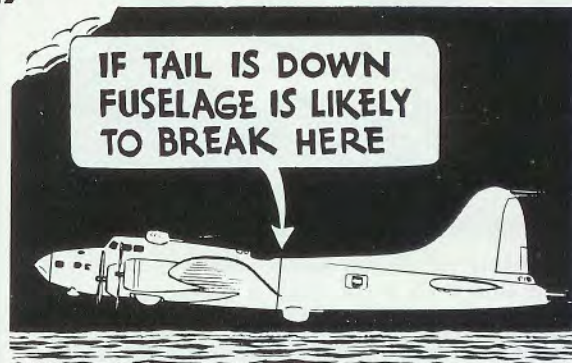

The water should be touched at about 90 mph. Come in as level as possible.

15

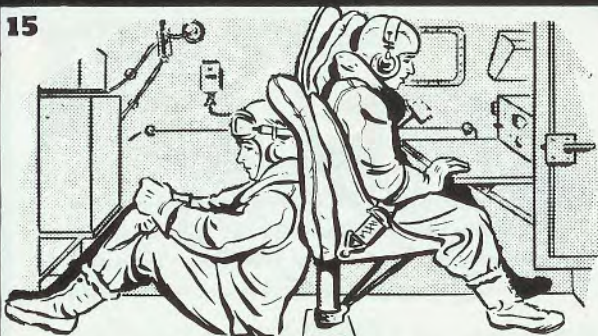

All members should have life vests on, parachutes removed, and should have on all extra clothing to be worn on rafts. At night, turn off all bright internal lights and use only the amber lamps.

18



As soon as the airplane has come to rest the predesignated member will pull the life raft handles.

14. EMERGENCY OPERATION
OF RADIO EQUIPMENT.

a. PORTABLE EMERGENCY RADIO
TRANSMITTER (Type SCR-578-A).

(1) GENERAL.

(a) A complete self-contained portable emergency transmitter is stowed on the right rear side of bulkhead 6, and is provided for operation anywhere away from the airplane. It is primarily designed for use in a small boat or life raft, but it may be placed in operation anywhere a kite can be flown or where water may be found.

(b) When operated, the transmitter emits an MCW signal and is pretuned to the international distress frequency of 500 kilocycles. Automatic transmission of a predetermined signal is provided. Any searching party can "home" on the signal with the aid of a radio compass.

(c) No receiver is provided.

(2) REMOVAL FROM AIRPLANE.

(a) If the airplane has made an emergency landing on water, the emergency set should be removed at the same time that the life raft is removed. The set is waterproof and will float, and it is not necessary to take any precautions in keeping the equipment out of the water; however, be sure that it does not float out of reach.

(b) The emergency set may be dropped from the airplane by use of the parachute attached. The altitude of the airplane when dropping the equipment should be between 300 and 500 feet. To drop the equipment, the following steps should be observed:

1. Tie the loose end of the parachute static line to any solid metal structure of the airplane.

CAUTION

Be sure that the static line is in the clear and will not foul.

2. Throw the emergency set out through a convenient opening in the airplane. Parachute will be opened by the static line.

CAUTION

Do not attach static line to any part of one's clothing or body when throwing the equipment through the opening.

(3) OPERATION. - Complete operating instructions are contained in one of the bags which contain the equipment. Complete instructions for the use of the transmitter are also located on the transmitter itself.

b. INTERPHONE EQUIPMENT FAILURE. - In the event of interphone equipment failure, the audio frequency section of the command transmitter may be substituted for the regular interphone amplifier. To make this connection, the pilot should place his command transmitter control box channel selector switch in either channel No. 3 or 4 position. Set the interphone jack-box selector switch on the "COMMAND" to place the interphone equipment in operation.

NOTE

When the command transmitter control box channel selector switch is set in either the No. 3 or 4 position for emergency operation of the interphone equipment, it is not possible to establish communication with any station or any other airplane. It is possible at all times to resume normal command set operation by placing the channel selector switch of the command transmitter control box in either the No. 1 or 2 position.

c. SUBSTITUTION OF RADIO COMPASS RECEIVER FOR LOW FREQUENCY COMMAND SET RECEIVER. - If the low frequency receiver of the command set fails, the radio compass receiver may be substituted, with the pilot having direct control over the compass receiver. To complete this emergency hook-up, the pilot must set his interphone jack-box selector switch in the "COMP" position and then place the radio compass selector switch in the "ANT" position. The radio compass can then be tuned as desired.

d. SUBSTITUTION OF LIAISON RECEIVER FOR LOW, MEDIUM, AND/OR HIGH FREQUENCY COMMAND RECEIVER. - In case of the failure of the low, medium, and/or high frequency receiver of the command radio equipment, the liaison receiver may be substituted, but the pilot will have only limited control over it. The pilot should first call the radio operator on the interphone system and tell him what frequency he desires to receive, that he is switching the interphone selector switch to the "LIAISON" position, and for him (the radio operator) to tune in this frequency and maintain the setting until further advised.

e. COMMAND SET TRANSMITTER FAILURE. - In case of failure of the command set transmitter, the liaison transmitter may be substituted. The pilot should first call the radio operator on the interphone and have him adjust the liaison transmitter to the frequency he desires to use. He should then set his interphone selector switch to the "LIAISON" position and operate his microphone button in the same manner that he did when the command set was in operation. When he is through using the liaison transmitter, the pilot should place the interphone selector switch in the "INTER" position and tell the radio operator to cut the liaison transmitter off, so as to reduce the load on the electrical system.

In the
o fre-
ay be
r. To
com-
switch
inter-
AND'

bx
he
on
s-
a-
ll
a-
of
er

CEIV-
RE-
com-
ay be
over
gency
k-box
place
posi-
ired.

FOR
COM-
low,
com-
ay be
ntrol
rator
gency
nter-
, and
gency

. - In
, the
pilot
hone
fre-
t his
osi-
ame
as in
ans-
ctor
op-
re-

NOTE

When substituting one receiver for another, such as the compass receiver for the command receiver, the pilot must move his interphone selector switch to the "COMMAND" or "LIAISON" position, as the case may be, in order to transmit. At the end of the transmission, he must switch back to the position of the receiver being used. This will have to be done every time that the pilot desires to hold a two-way conversation.

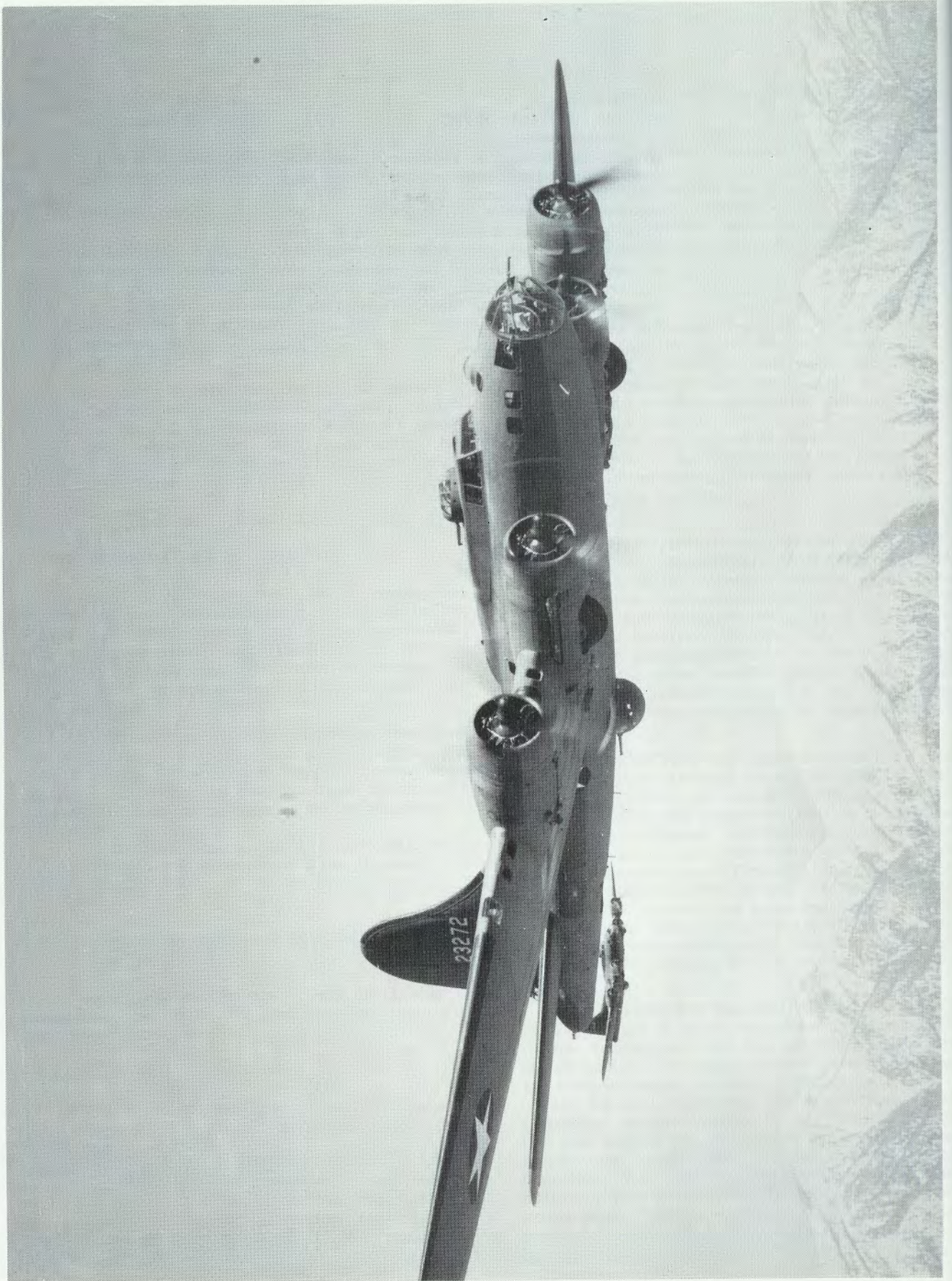

SECTION IV BOMBARDIER'S COMPARTMENT

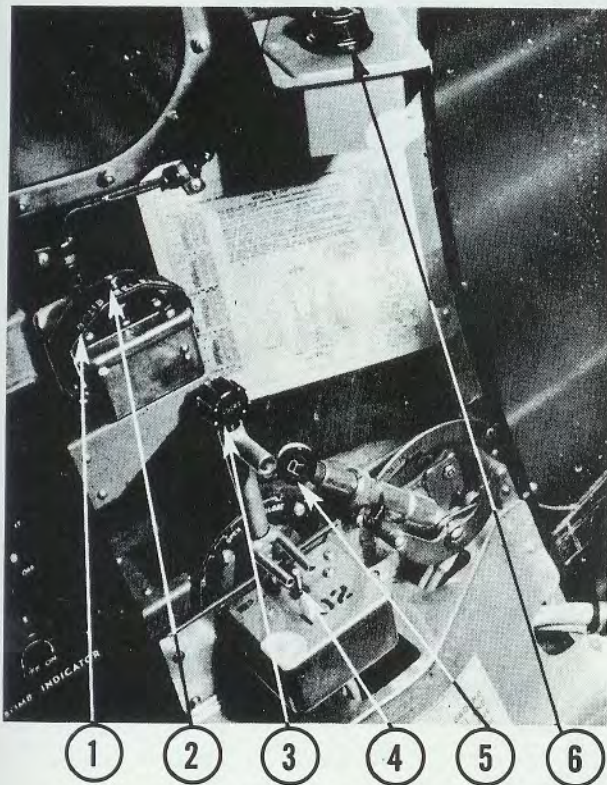

KEY TO FIGURE 38

1. BOMB RELEASE SWITCH GUARD
2. BOMB RELEASE SWITCH
3. BOMB DOOR CONTROL HANDLE
4. BOMB DOOR SWITCH
5. BOMB RELEASE HANDLE
6. BOMBARDIER'S LIGHT SWITCH

Figure 38 - Bomb Controls

1. BOMB CONTROLS.

a. Bombs are normally released electrically, but can be released mechanically in an emergency. Electrical control provides for individual release of bombs either singly (selective) or continuously at predetermined intervals (train). Mechanical control is always in "SALVO," by operation of the bombardier's release handle or by operation of the emergency release handles. The bomb release handle has three positions.

(1) In the "LOCK" position the bomb racks are locked against any release of bombs except by means of the emergency release handles.

(2) In the "SELECTIVE" position the bomb racks are prepared for electrical release by manual operation of the release switch, or by automatic operation through the bomb sight.

(3) The "SALVO" position, when the bomb doors are open, mechanically releases all bombs simultaneously and unarmed.

b. The bombardier's release switch, mounted on the forward end of the control panel, operates in either direction to energize the release unit solenoids through the interval release control mechanism. A hinged guard prevents accidental operation of this switch.

c. The interval release control unit is mounted at the bottom of the bombardier's control panel and may be set to provide either "SELECT" or "TRAIN" release. On airplanes serial Nos. 42-5050 and on, four switches on the bombardier's control panel permit selection of any external or internal rack for electrical release. Two indicator lamps beside the rack selector switches correspond to the external racks. Two additional rack selector switches in the bomb bay permit elimination of either right or left bomb bay from the release circuit if bomb bay fuel tanks are carried. Bomb release sequence is given in figure 40. Any rack or combination of racks may be eliminated from the release sequence by turning off

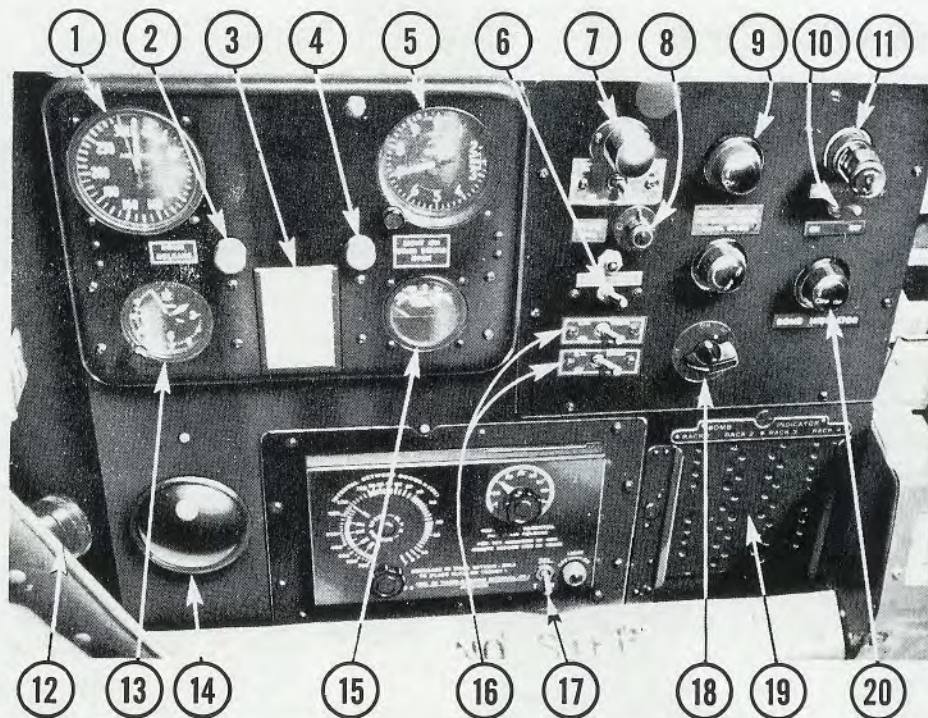

KEY TO FIGURE 39

- | | | | |
|-------------------------------|----------------------------|---------------------------------|---|
| 1. AIR SPEED INDICATOR | 6. PILOT CALL SWITCH | 12. ULTRA-VIOLET SPOT LIGHT | 17. BOMB INTERVAL SWITCH |
| 2. BOMB RELEASE WARNING LAMP | 7. PANEL LIGHT | 13. CLOCK | 18. ULTRA-VIOLET SPOTLIGHT CONTROL SWITCH |
| 3. ALTIMETER SCALE ERROR CARD | 8. PHONE CALL LAMP | 14. ASH RECEIVER | 19. BOMB INDICATOR |
| 4. BOMB DOOR WARNING LAMP | 9. WARNING LAMP RHEOSTAT | 15. FREE AIR THERMOMETER | 20. BOMB INDICATOR CONTROL KNOB |
| 5. ALTIMETER | 10. EXTENSION LIGHT SWITCH | 16. BOMB RACK SELECTOR SWITCHES | |
| | 11. EXTENSION LIGHT | | |

Figure 39 - Bombardier's Control Panel

the respective selector switch on the bombardier's control panel.

d. A bomb arming solenoid in each external rack is controlled by a switch on the bombardier's panel. A red indicator lamp beside the switch is on when the bombs are armed.

NOTE

Some B-17F airplanes not equipped for external racks have only two rack selector switches and no bomb arming switch on the bombardier's panel. A few airplanes have no rack selector switches on the bombardier's panel but have a three-position switch in the bomb bay to turn off either internal rack.

e. The bomb door control handle is at the left of the bombardier, forward of the control panel, and operates a double-throw toggle switch controlling the solenoid switches for the bomb door retracting motor. A lug on the side of the handle is located so that when the door handle is in the "CLOSED" position, the bomb release lever cannot be moved out of the "LOCK" position.

CAUTION

If bombs are carried above the 2000-pound bomb, they **MUST NOT** be released until the D-6 shackle and adapter have been removed. This definitely requires "SELECTIVE" release control for the 2000-pound bomb.

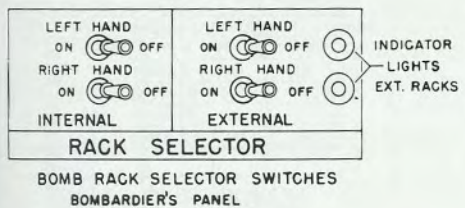
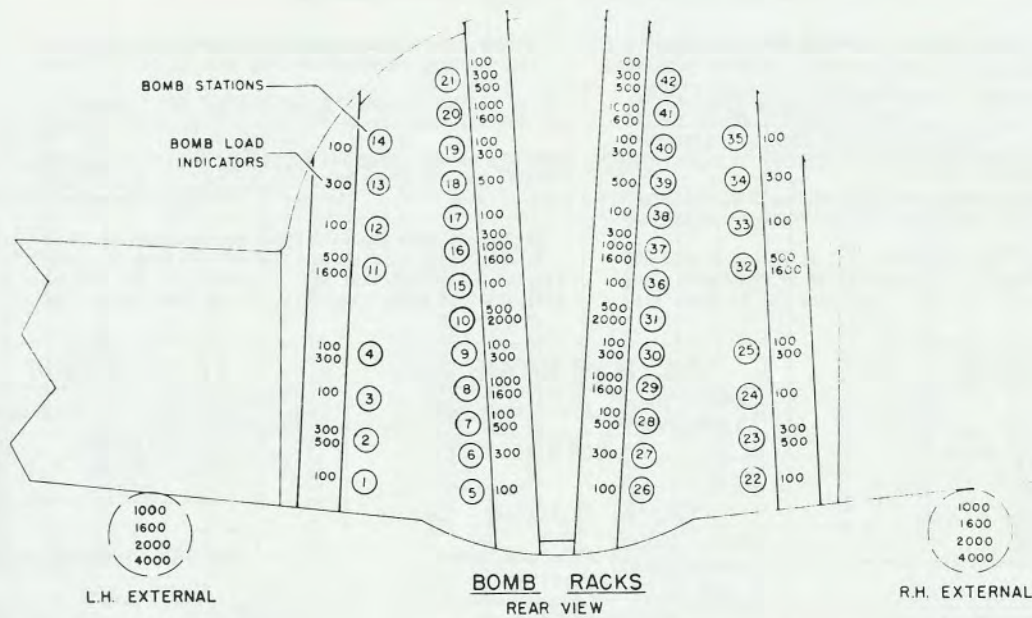

NOTE: ANY UNLOADED OR UNCOCKED STATION WILL BE AUTOMATICALLY SKIPPED IN THE RELEASE SEQUENCE AND THE REMAINING STATIONS RELEASED ACCORDING TO THE NORMAL SEQUENCE.

BOMB BAY DOORS MUST BE OPEN TO DROP ANY BOMBS

CAUTION: CLOSING THE BOMB DOORS, RETURNING THE BOMB RELEASE LEVER TO LOCK, OR TURNING OFF ANY RACK SELECTOR SWITCH MAY CAUSE THE RELEASE SEQUENCE TO RESUME AT SOME STATION OTHER THAN THE NEXT IN THE NORMAL SEQUENCE DUE TO THE ACTION OF THE RACK SELECTOR RELAYS.

EXAMPLES

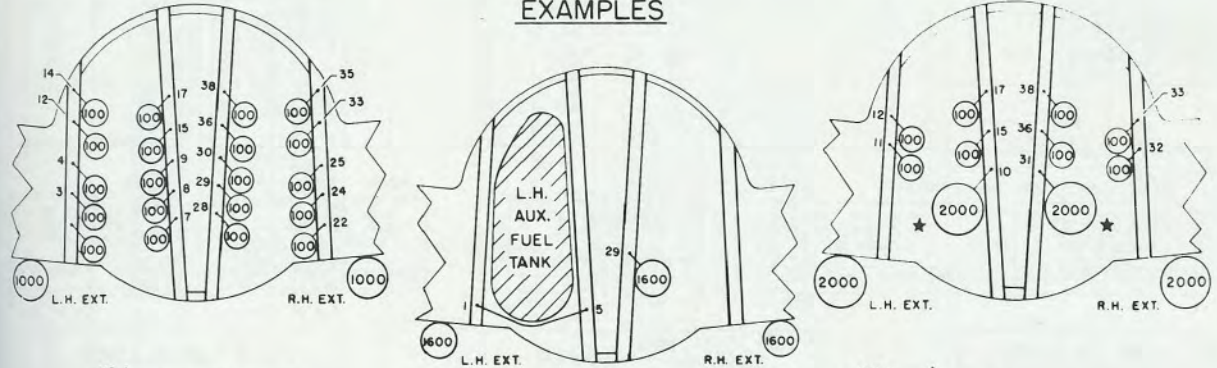

NO. 1

INTERNAL RACKS ON EXTERNAL RACKS ON			
SEQ.	STA.	SEQ.	STA.
1	1	12	29
2	R.H. EXT.	13	9
3	22	14	30
4	L.H. EXT.	15	12
5	3	16	33
6	24	17	14
7	4	18	35
8	25	19	15
9	7	20	36
10	28	21	17
11	8	22	38

NO. 4

L.H. INT. OFF R.H. INT. ON EXT. RACKS ON			
SEQ.	STA.	SEQ.	STA.
1	R.H. EXT.		
2	L.H. EXT.		
3	29		

NO. II

INT. RACKS OFF EXT. RACKS ON	
SEQ.	STA.
1	R.H. EXT.
2	L.H. EXT.

NO. 2

INT. RACKS ON EXT. RACKS OFF	
SEQ.	STA.
1	11
2	32
3	12
4	33
5	15
6	36
7	17
8	38

II RELEASE TWO 2000 LB BOMBS SELECT OR TRAIN OF 2.

★ LARGE TYPE D-6 SHACKLE MUST BE REMOVED BEFORE RELEASING BOMBS ABOVE.

Figure 40 - Bomb Release Sequence Diagram (Sheet 1)

ANY BOMB LOAD WILL BE RELEASED ACCORDING TO ONE OF THESE SEQUENCES. COMBINATIONS OF RELEASE SEQUENCES FOR A PARTICULAR BOMB LOAD ARE POSSIBLE BY OPERATION OF THE RACK SELECTOR SWITCHES BETWEEN "STICKS." (SEE CAUTION ON SHEET NO.1)

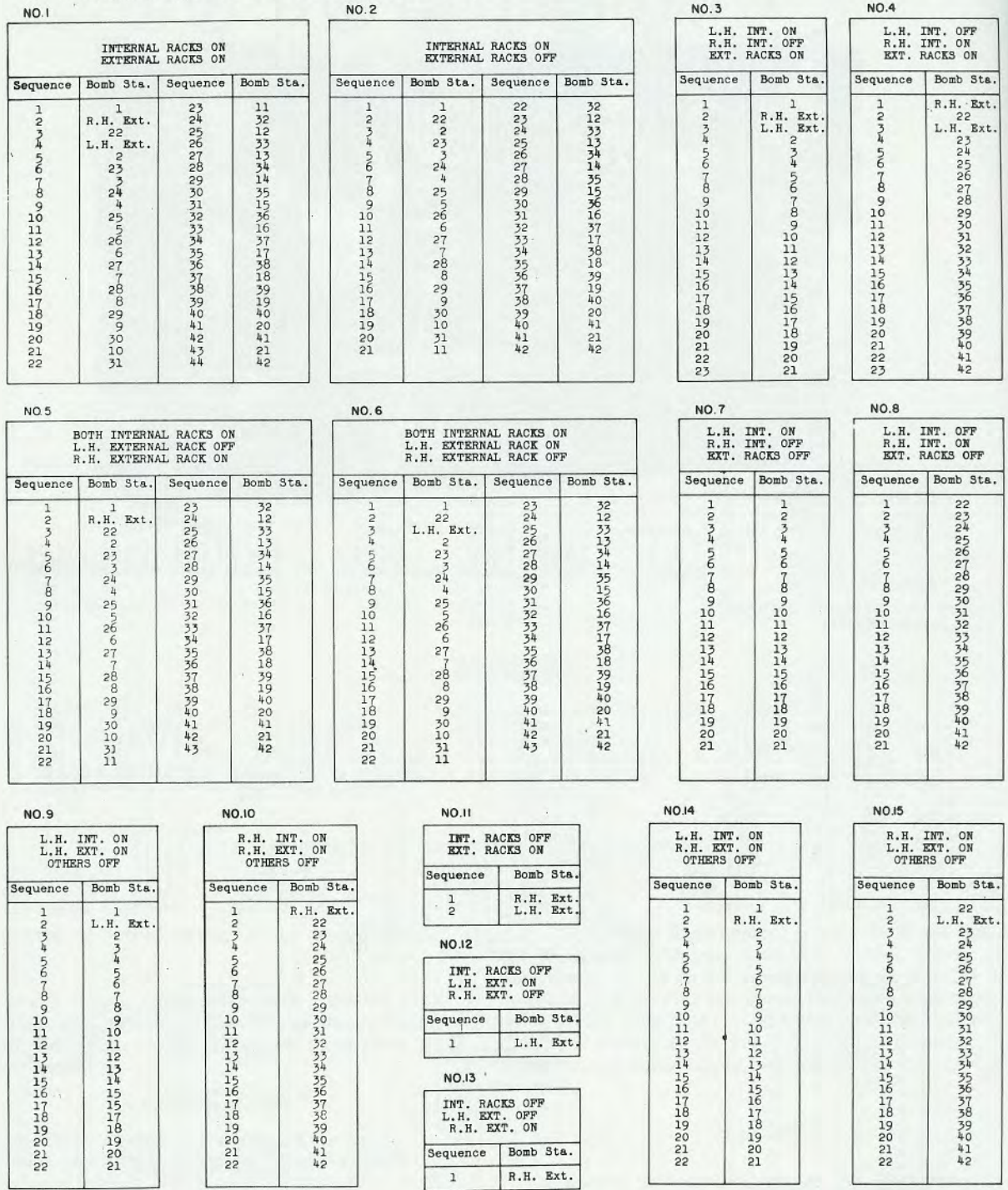

Figure 40 - Bomb Release Sequence Diagram (Sheet 2)

MAXIMUM AIRPLANE GLIDE & CLIMB ANGLES FOR BOMB RELEASE

WITH WHEELS AND FLAPS UP: MAXIMUM ALLOWABLE INDICATED AIR SPEED 1° 270 MPH SAFE GLIDE ANGLE IS 15-1/4°.

SHALL THE MAXIMUM ALLOWABLE INDICATED AIR SPEED BE EXCEEDED.

WITH WHEELS AND FLAPS DOWN: MAXIMUM ALLOWABLE INDICATED AIR SPEED IS 147 MPH SAFE GLIDE ANGLE IS 13-1/2°.

ANGLES SHOWN ALLOW 10° FOR SAFETY. HOWEVER, UNDER PERFECTLY SMOOTH FLYING CONDITIONS, IF IN THE AIRPLANE COMMANDER'S OPINION CONDITIONS WARRANT IT, THESE GIVEN ANGLES MAY BE EXCEEDED BY NOT MORE THAN 5°.

NOTE: THE SAFE GLIDE ANGLES ARE BASED ON AN AIRPLANE GROSS WEIGHT OF 40,000 LBS WITH POWER OFF AND WIND-MILLING PROPELLERS.

THE GLIDE OR CLIMB ANGLE IS THE ANGLE INCLUDED BETWEEN THE EARTH'S SURFACE AND THE FUSELAGE CENTERLINE.

WHILE THE MAJORITY OF BOMB STATIONS WILL PERMIT RELEASE OF BOMBS AT AN ANGLE WHICH WILL PRODUCE AN INDICATED AIR SPEED GREATER THAN THAT DESIGNATED FOR THE SAFE GLIDE ANGLE OF THE AIRPLANE, UNDER NO CONDITIONS

THE ANGLES LISTED IN THE TABULATION ARE THE MAXIMUM AT WHICH BOMBS MAY BE RELEASED WITH A 10° CLEARANCE ANGLE MAINTAINED IN THE BOMB BAY.

1100LB. M-33			
RACK NO.	STA.	GLIDE ANGLE	CLIMB ANGLE
2 & 3	2988	26	15
	37816	11	6 1/2
	41820	5	2

2000LB. M-34			
RACK NO.	STA.	GLIDE ANGLE	CLIMB ANGLE
2 & 3	31810	0	0

500LB. M-43			
RACK NO.	STA.	GLIDE ANGLE	CLIMB ANGLE
1 & 4	2823	33	33 1/2
	11832	17	19 1/2
2 & 3	2887	34 1/2	34
	31810	18 3/4	21
	39818	10	12 1/2
	42821	5 1/2	8

300LB. MK.I - MK.IMI			
RACK NO.	STA.	GLIDE ANGLE	CLIMB ANGLE
1 & 4	2823	37	33 3/4
	4825	23 3/4	22
	13834	14 3/4	15
2 & 3	2786	44 1/2	40
	3089	27	25
	37816	17 1/4	16 1/4
	40819	11 1/2	11 1/4
	42821	8	8

600LB. M-32			
RACK NO.	STA.	GLIDE ANGLE	CLIMB ANGLE
1 & 4	2823	32 1/2	29
	2887	34 1/2	29 1/2
2 & 3	31810	18	17 1/2
	39818	10	10
	42821	5 1/2	6

1100LB. MK. III			
RACK NO.	STA.	GLIDE ANGLE	CLIMB ANGLE
2 & 3	2988	23 1/2	9
	37816	10	1 1/2
	41820	4	0

100LB. M-38A2			
RACK NO.	STA.	GLIDE ANGLE	CLIMB ANGLE
1 & 4	1822	49 3/4	44 1/2
	3824	40	32
	4825	29 1/2	26 3/4
	12833	23	20 3/4
	14835	20	15
2 & 3	2685	57 1/2	52
	2887	44 1/4	39 3/4
	3089	33	29 1/2
	36815	25	22 1/2
	38817	19 3/4	18
	40819	15 1/2	14 1/4
	42821	11 1/2	10 1/2

600LB. MK.IMI-MK.II			
RACK NO.	STA.	GLIDE ANGLE	CLIMB ANGLE
2 & 3	2887	33	23
	31810	18	12 1/2
	39818	9 1/2	6 1/2
	42821	5	2 1/2

1600 LB. AN-MKI			
RACK NO.	STA.	GLIDE ANGLE	CLIMB ANGLE
1 & 4	11832	7	1 1/2
	8829	16 1/2	6 1/2
2 & 3	16837	4 1/2	0
	20841	0	0

100LB. M-30			
RACK NO.	STA.	GLIDE ANGLE	CLIMB ANGLE
1 & 4	1822	47 3/4	51
	3824	36 1/2	41
	4825	28 1/4	33 1/2
	12833	22	27 1/2
	14835	17 1/2	22 3/4
2 & 3	2685	56	57 1/2
	2887	42 1/2	46 1/2
	3089	31 1/2	36 1/2
	36815	23 3/4	29 1/2
	38817	19	24
	40819	15	20
	42821	11 1/4	15 3/4

300LB. M-31			
RACK NO.	STA.	GLIDE ANGLE	CLIMB ANGLE
1 & 4	2823	38	38 1/2
	4825	24	26 1/2
	13834	16	18 3/4
2 & 3	2786	45	44 3/4
	3089	27 1/4	29 1/2
	37816	17 1/2	20
	40819	11 3/4	14 1/2
	42821	8 1/4	10 1/2

1000LB. M-44			
RACK NO.	STA.	GLIDE ANGLE	CLIMB ANGLE
2 & 3	2988	25	17
	37816	11	8
	41820	5	3

100LB. MK.I-MK.IMI MK.II			
RACK NO.	STA.	GLIDE ANGLE	CLIMB ANGLE
1 & 4	1822	46 1/4	45
	3824	34 1/2	34 3/4
	4825	26 1/4	27
	12833	20 1/2	21 1/2
	14835	16	16 3/4
2 & 3	2685	54 1/2	52 1/2
	2887	40 3/4	40 1/4
	3089	29 3/4	30
	36815	22	23
	38817	17 1/4	19 1/4
	40819	13 1/2	14 1/2
	42821	9 3/4	10 3/4

100LB. M-39			
RACK NO.	STA.	GLIDE ANGLE	CLIMB ANGLE
1 & 4	1822	46 1/4	45
	3824	34 1/2	34 3/4
	4825	26 1/4	27
	12833	20 1/2	21 1/2
	14835	16	16 3/4
2 & 3	2685	54 1/2	52 1/2
	2887	40 3/4	40 1/4
	3089	29 3/4	30
	36815	22	23
	38817	17 1/4	19 1/4
	40819	13 1/2	14 1/2
42821	10	10 3/4	

Figure 41 - Bomb Release Angles Chart

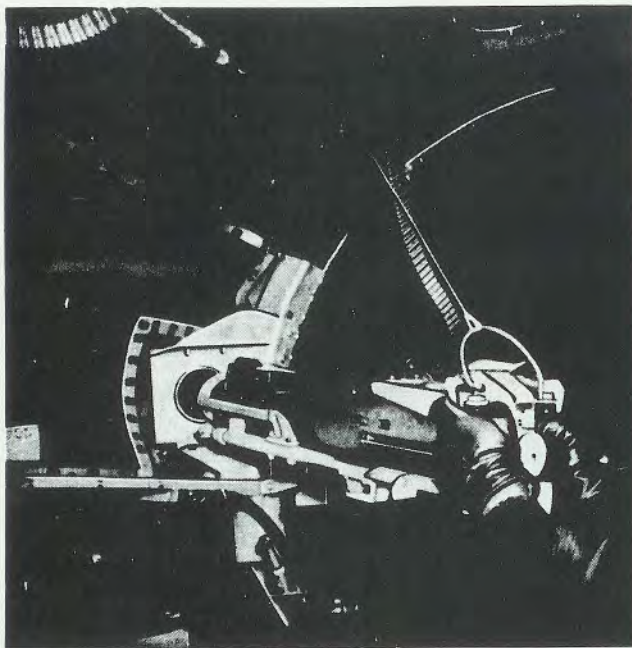

Figure 42 - Bombardier's Gun - Left Side

2. BOMBARDIER'S GUNS.

a. Most airplanes have two .50-caliber machine gun installations, one mounted through a window on either side of the bombardier's compartment. A .50-caliber gun is also mounted in the center Plexiglas nose of some airplanes. In some airplanes ball and socket mounts are incorporated in the nose, side, and top windows for insertion of a .30-caliber machine gun.

b. On B-17G airplanes a type A-16 chin turret with two .50 calibre machine guns is mounted below, and is remotely controlled from, the bombardier's compartment.

3. INTERPHONE.

Two interphone jack boxes are on the right side of the compartment. Operating instructions are given in section I, paragraph 10.

4. OXYGEN.

The oxygen regulator and indicator panel are on the right wall of the compartment. Operating instructions are given in section I, paragraph 9.

5. BOMB-SIGHT WINDOW DEFROSTER.

A control knob in the floor in front of the bombardier's seat controls the flow of air to the bomb-sight window. Push forward to shut off the flow of air; pull aft to allow air to reach the bomb-sight window. Selection of hot and cold air is made by the pilot.

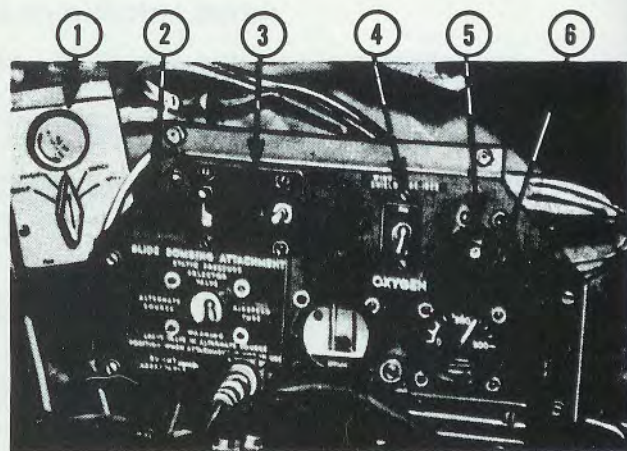
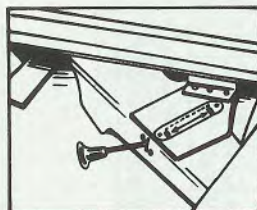

KEY TO FIGURE 43

- | | |
|---|-------------------------------------|
| 1. INTERPHONE JACKBOX | 4. WINDSHIELD ANTI-ICER PUMP SWITCH |
| 2. GLIDE BOMBING ATTACHMENT STATIC PRESSURE SELECTOR SWITCH | 5. ANTI-ICER ALCOHOL FLOW VALVE |
| 3. WINDSHIELD WIPER CONTROLS | 6. OXYGEN INDICATORS |

Figure 43 - Bombardier's Compartment - Right Side

6. WINDSHIELD WIPER AND ANTI-ICER.

Anti-icer and wiper controls for the bomb-sight window are on a panel at the bombardier's right.

a. A toggle switch regulates the wiper motor "OFF," "SLOW," or "FAST." A circuit breaker protects the circuit in case of an overload.

b. An "ON-OFF" switch controls the alcohol and flow is regulated by a needle valve.

CAUTION

Do not operate the wiper on dry glass.

7. BOMB-SIGHT HEATING PAD.

Most airplanes are equipped with an electrical bomb-sight heating pad which may be plugged into the bombardier's suit heater receptacle.

Figure 44
Bombardier's Seat Adjustment



SECTION V NAVIGATOR'S COMPARTMENT

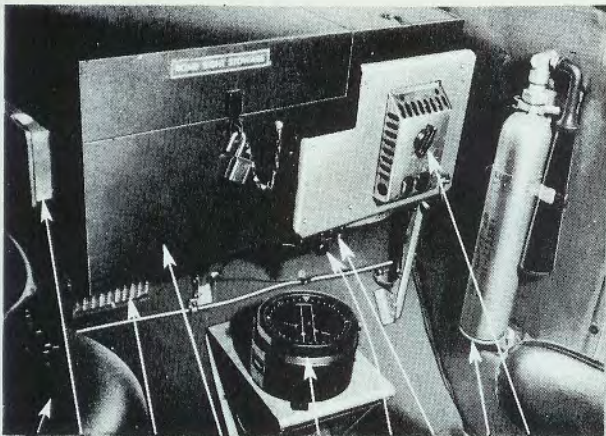
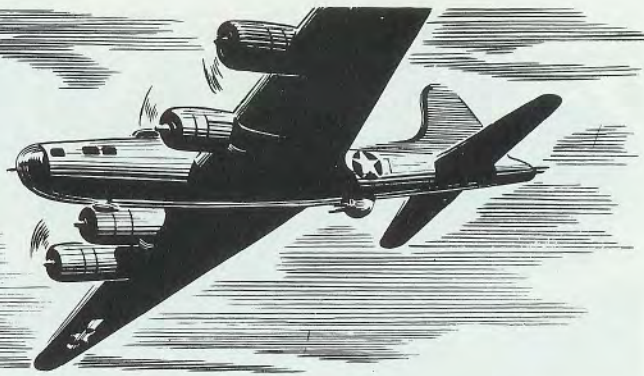

KEY TO FIGURE 45

- | | |
|--------------------------------------|-----------------------|
| 1. DRIFT METER | 5. APERIODIC COMPASS |
| 2. FUSE BOX | 6. PANEL LIGHT |
| 3. HEATING AND VENTILATING
OUTLET | 7. PANEL LIGHT SWITCH |
| 4. BOMB SIGHT STOWAGE BOX | 8. FIRE EXTINGUISHER |
| | 9. SUIT HEATER OUTLET |

Figure 45 - Navigator's Compartment
Right Rear Corner

1. LIGHTING.

A dome light and switch are in the ceiling of the compartment. A panel light and switch are above the navigator's table on the aft wall. The navigator's light is on the wall directly over his table; the switch is on the base of the lamp.

2. FIRE EXTINGUISHER.

A hand CO₂ fire extinguisher is clipped to the aft wall of the compartment to the right of the door.

3. INTERPHONE.

The interphone jack box is between the radio compass control box and the map case. Operating instructions are given in section I, paragraph 10.

4. OXYGEN.

The oxygen regulator is on the wall above the navigator's table. Refer to section I, paragraph 9.

5. HEATING AND VENTILATING INLET.

The inlet beneath the bomb-sight storage box is equipped with a push-pull knob for regulating the flow

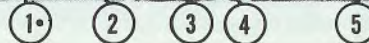
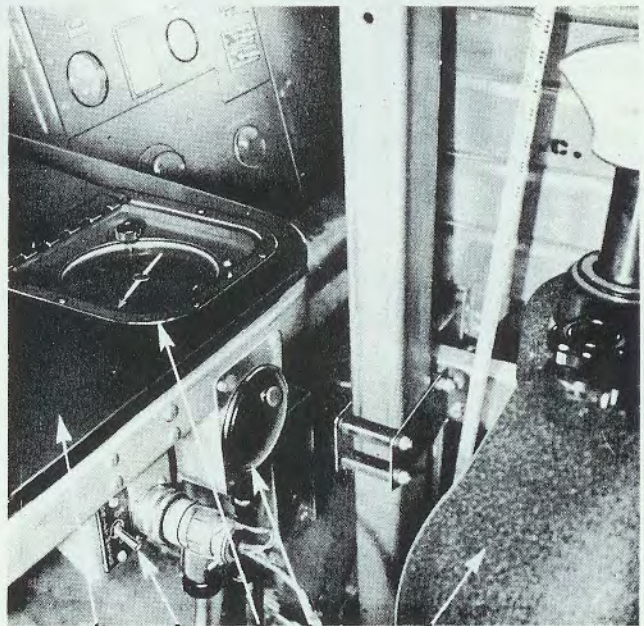

KEY TO FIGURE 46

- | |
|------------------------------|
| 1. NAVIGATOR'S TABLE |
| 2. DRIFT METER MASTER SWITCH |
| 3. RADIO COMPASS INDICATOR |
| 4. ASH RECEIVER |
| 5. DRIFT METER |

Figure 46 - Navigator's Equipment

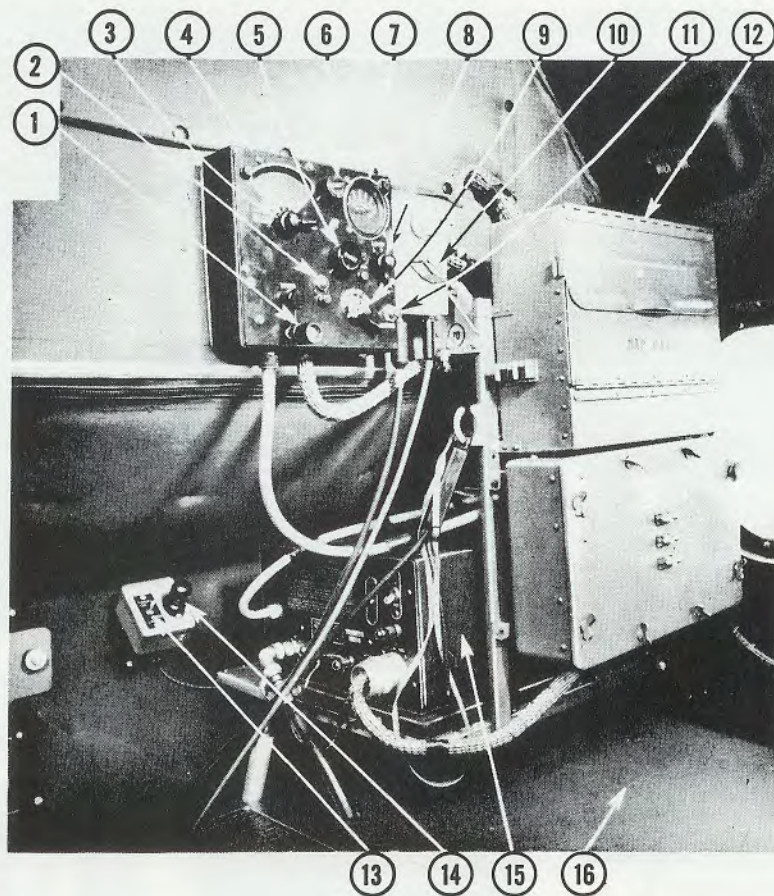

KEY TO
FIGURE 47

1. TUNING CRANK
2. CONTROL INDICATOR LAMP
3. BAND SELECTOR SWITCH
4. RADIO COMPASS CONTROL UNIT
5. VOLUME CONTROL
6. LIGHT CONTROL SWITCH
7. TUNING METER
8. LOOP CONTROL SWITCH
9. RADIO COMPASS POWER SWITCH
10. INTERPHONE JACKBOX
11. CONTROL PUSH BUTTON
12. MAP CASE
13. PANEL LIGHT SWITCH
14. PANEL LIGHT
15. RADIO COMPASS RECEIVER
16. NAVIGATOR'S TABLE

Figure 47 - Navigator's Communications Controls

of air. Push to open and pull to close. The selection of hot or cold air is made by the pilot.

6. DRIFT METER MASTER SWITCH.

A master switch for the drift meter is below the edge of the navigator's table near the ash receiver on the front forward corner.

7. RADIO COMPASS RECEIVER.

a. The radio compass receiver is above the navigator's table and may be remotely controlled either from the pilot's compartment ceiling or from the control unit on the navigator's table. Operation of the radio compass receiver is the same for the navigator as for the pilot. Refer to section II, paragraph 2.

b. The bearing indicator is mounted beneath the forward inboard corner of the navigator's table and its dial may be seen by lifting the cover on the table. The loop antenna is remotely controlled from the radio compass receiver.

8. APERIODIC COMPASS.

The navigation compass is on the right side of the compartment, below the bomb-sight storage box.

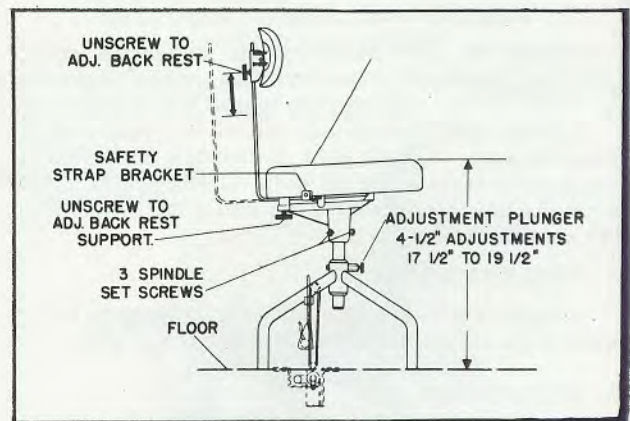
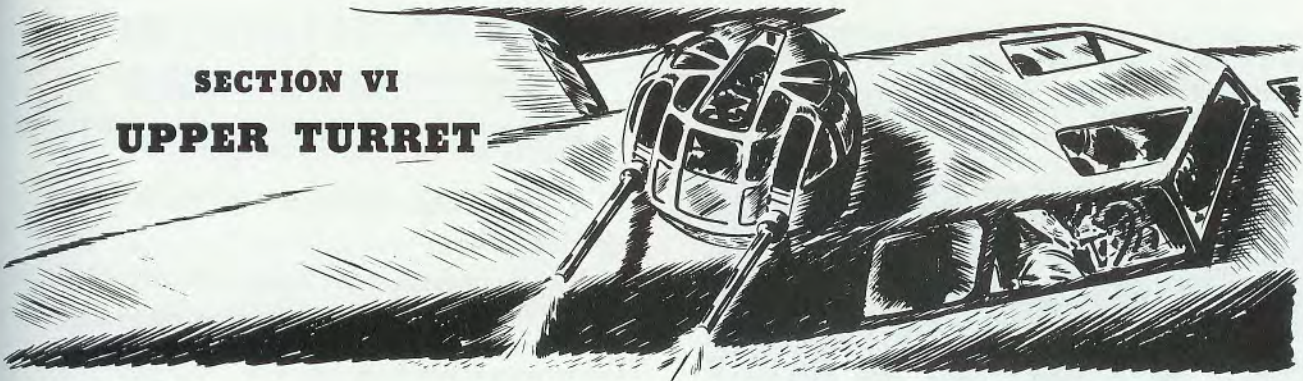

Figure 48 - Navigator's Seat Adjustment

SECTION VI UPPER TURRET



1. GENERAL.

a. Elevation of the guns is controlled by lifting or depressing the hand control grips, the direction corresponding to the direction of the handgrip motion about the horizontal axis.

b. Rotation of the turret is obtained by turning the handgrips about the vertical axis. The range knob is mounted between the grips, so that the gunner rests both thumbs on this knob while holding the grips in the palms of his hands. This knob sets the range in the computing sight.

c. The hydraulic power unit furnishes the mechanical power for rotating the turret and elevating the guns.

d. A gun firing switch is mounted to the rear and at the upper end of each handgrip. The two firing

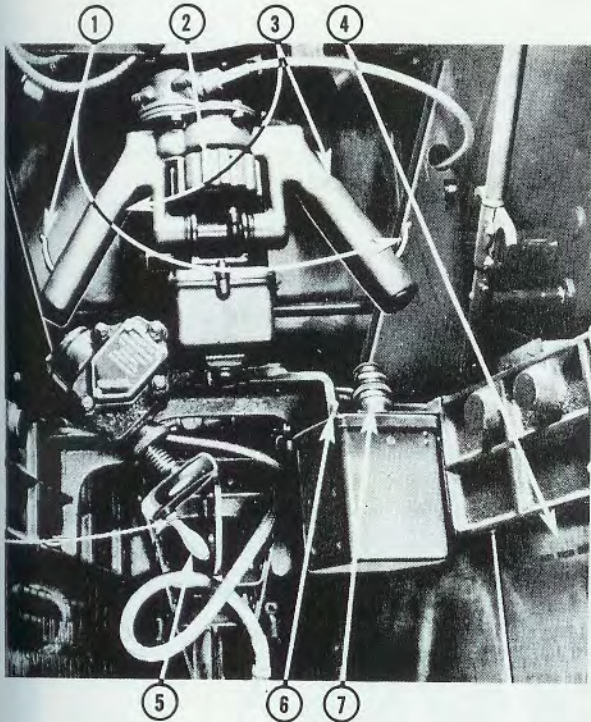

KEY TO FIGURE 49

- | | |
|-------------------|-------------------------|
| 1. DEADMAN SWITCH | 5. AZIMUTH HANDCRANK |
| 2. RANGE KNOB | 6. TROUBLE LIGHT SWITCH |
| 3. HAND GRIP | 7. TROUBLE LIGHT |
| 4. AMMUNITION BOX | |

Figure 49 - Upper Turret Controls

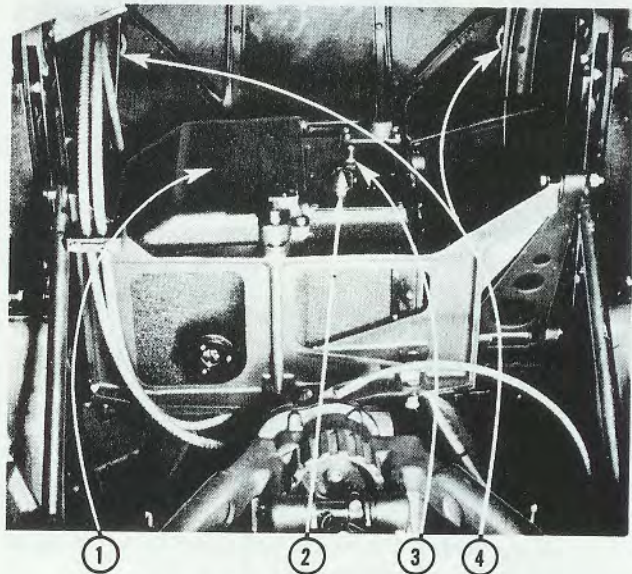

KEY TO FIGURE 50

- | |
|---------------------------------|
| 1. GUN SIGHT |
| 2. SIGHT LIGHT RHEOSTAT CONTROL |
| 3. SIGHT SWITCH |
| 4. GUN CHARGING HANDLES |

Figure 50 - Inside Upper Turret

switches are connected in parallel so that either switch can be used to fire the guns. Deadman switches, one on each grip, are connected in parallel so that the gunner can operate the turret when either hand rests on a grip. The deadman switch is provided so that the power circuits of the turret will be opened and all turret motion and firing of guns will be stopped when the gunner's hands are removed from the grips.

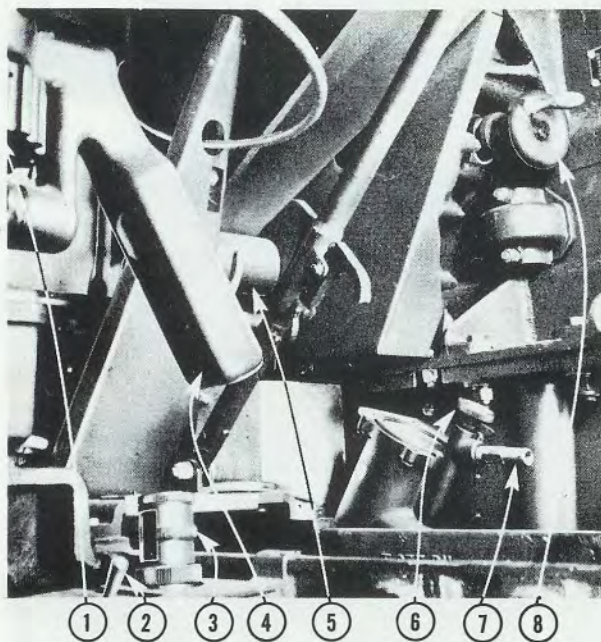

KEY TO FIGURE 51

- | | |
|-------------------------|------------------------|
| 1. RANGE KNOB | 5. DEADMAN SWITCH |
| 2. TROUBLE LIGHT SWITCH | 6. OXYGEN FLOW CONTROL |
| 3. TROUBLE LIGHT | 7. OXYGEN MASK FITTING |
| 4. HAND GRIP | 8. ELEVATION HANDCRANK |

Figure 51 - Upper Turret Interior

2. PREFLIGHT CHECK.

- a. Allow hydraulic units and sight to warm up at least 5 minutes before take-off.
- b. Engage power clutches.
- c. See that hand cranks are disengaged. (Do not disengage until after power clutches have been engaged.)
- d. Feed ammunition just up to the guns.
- e. Move main gun switch to "ON" position.

- f. Place sight switch in "ON" position.
- g. Close deadman switches on handgrips.
- h. Check response of azimuth and elevation mechanisms by manipulating the handgrips.
- i. Turn range knob and observe that reticles move in response.
- j. Adjust reticle light to approximately the desired brilliance.

3. TURRET OPERATION.

- a. Charge guns by pulling each handle twice.
- b. Turn on gun selector switches.
- c. When target is sighted, set in target dimension on sight.
- d. Turn hand controls so that reticles frame the target.
- e. Adjust range knob until reticles frame the target.
- f. Press either firing switch.
- g. After ammunition has been used, charge guns at least twice to clear out live shells.

h. When the turret is not being used, turn it so that the guns point aft and are parallel to the center line of the airplane.

i. In event of power failure, the turret may be controlled by the azimuth and elevation hand cranks. It is not possible to track a target with the hand cranks, but they may be used for approximate positioning of the turret and guns.

- j. To use the hand cranks:

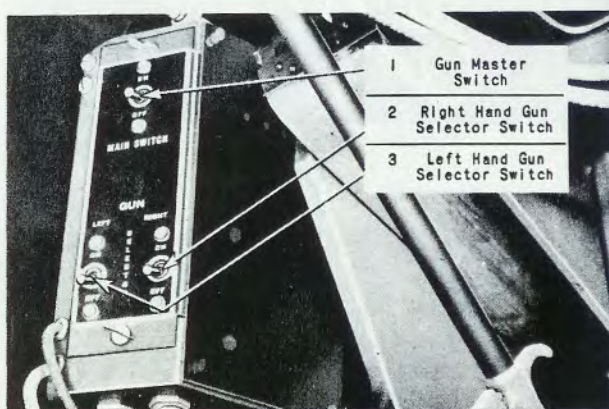

Figure 52 - Upper Turret Switches

- (1) Engage azimuth and elevation hand cranks.
- (2) Disengage power clutches.
- (3) Move turret and guns into desired position.
- (4) When finished, reengage power clutches.

(5) Be sure to disengage hand cranks before operating power motor again.

4. ADJACENT EQUIPMENT.

a. LIGHTING. - A panel light and switch are on the wall of the compartment to the left of the turret. A trouble light and switch are inside of the turret; on the right side looking aft.

b. INTERPHONE. - An interphone jack box is on the wall of the compartment to the left of the turret. Operating instructions are given in section I, paragraph 10.

c. OXYGEN.

(1) An A-12 demand oxygen regulator on the right wall of the compartment is part of the main oxygen system and is operated as instructed in section I, paragraph 9. A continuous flow regulator, type A-9 is inside the turret, on the right side looking aft, and is connected to a separate supply cylinder attached to the turret.

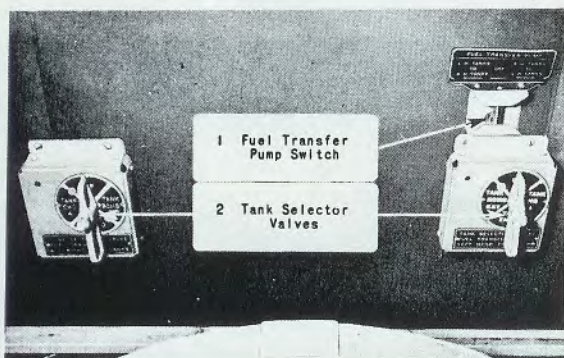

Figure 53 - Fuel Transfer Controls

(2) To use A-9A regulator, attach mask hose to regulator and open the manually operated valve until indicator points to altitude at which airplane is flying. If valve vibrates off setting, tighten packing nut.

(3) The turret supply cylinder can be refilled from the main supply system.

d. FUEL TRANSFER CONTROLS. - Two fuel transfer valves and the transfer pump switch are below the door leading to the bomb bay. Refer to section I, paragraph 4., for operating instructions.

e. HYDRAULIC EQUIPMENT. - The hydraulic pump panel, accumulators, fluid tank, and servicing valves are at the right side of the compartment. Refer to section I, paragraph 3.

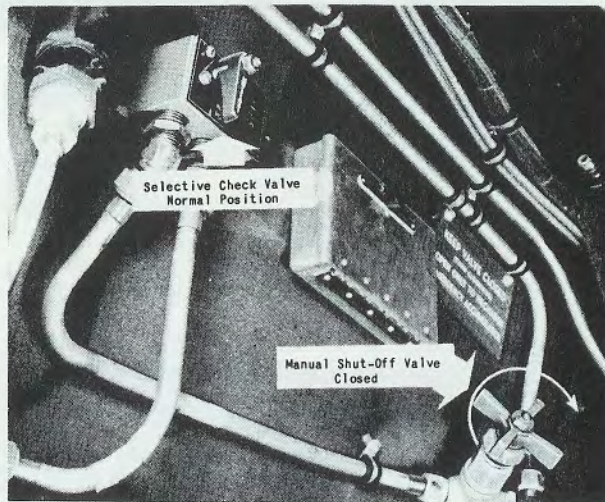

Figure 54 - Hydraulic Servicing Valves

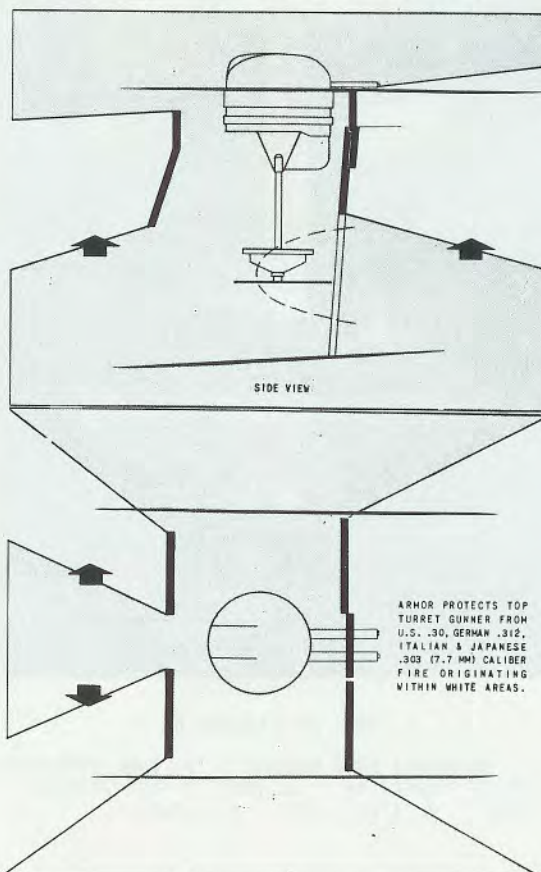
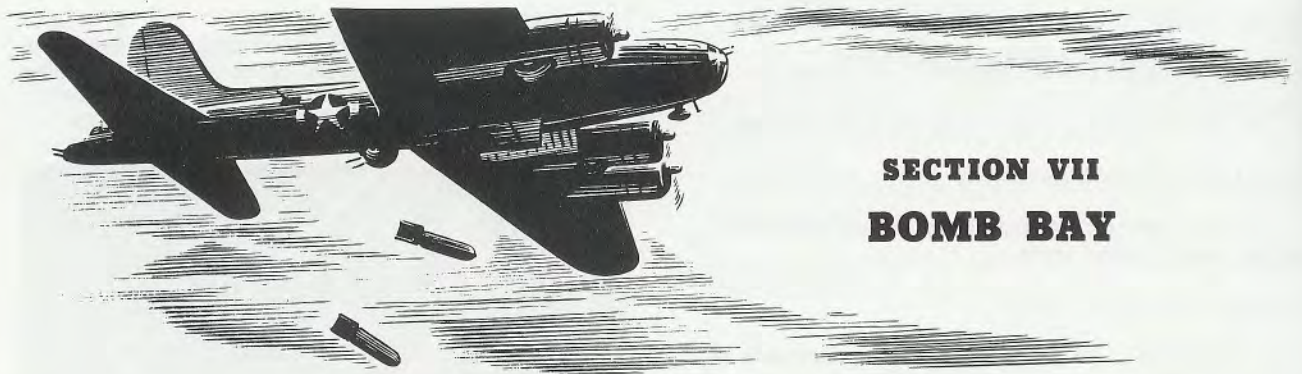

Figure 55 - Top Gunner's Armor Protection



SECTION VII BOMB BAY

1. LIGHTING.

a. The step light at the forward end of the catwalk is operated by a switch on the forward wall of the radio compartment, to the right of the door.

b. Two dome lights, one on either side of aft end of the bay, are operated by switches on the aft bulkhead to the right of the door.

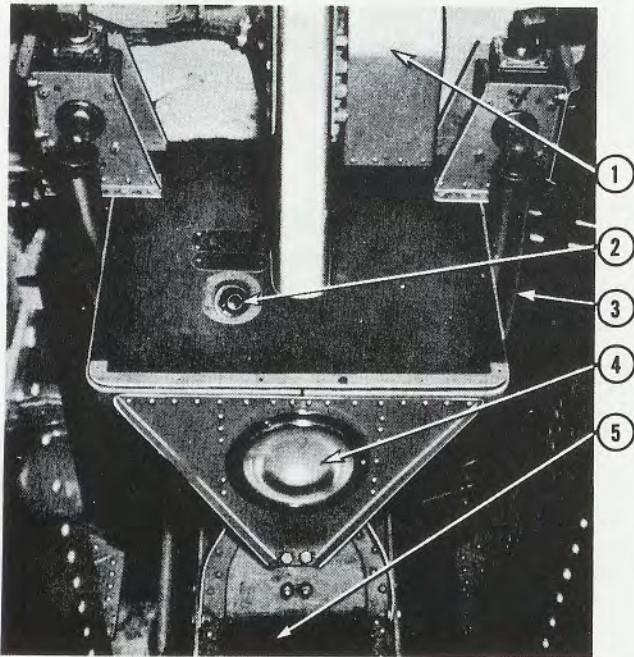

KEY TO FIGURE 56

1. EMERGENCY BOMB RELEASE 2. BOMB DOOR HAND
CRANK CONNECTION 3. HOSE TO FUEL TRANSFER
PUMP 4. STEP LIGHT 5. CATWALK

Figure 56 - Forward End of Catwalk - Bomb Bay

2. OXYGEN.

The oxygen regulator is on the aft wall of the bomb bay to the left of the door.

3. EMERGENCY EQUIPMENT.

a. A hand crank connection for manual operation of each main landing wheel is on the forward wall of the bomb bay.

b. A hand crank connection for manual operation of the bomb bay doors is on the step at the forward end of the catwalk.

c. An emergency bomb release handle is also on the step at the forward end of the catwalk and is protected by a hinged guard.

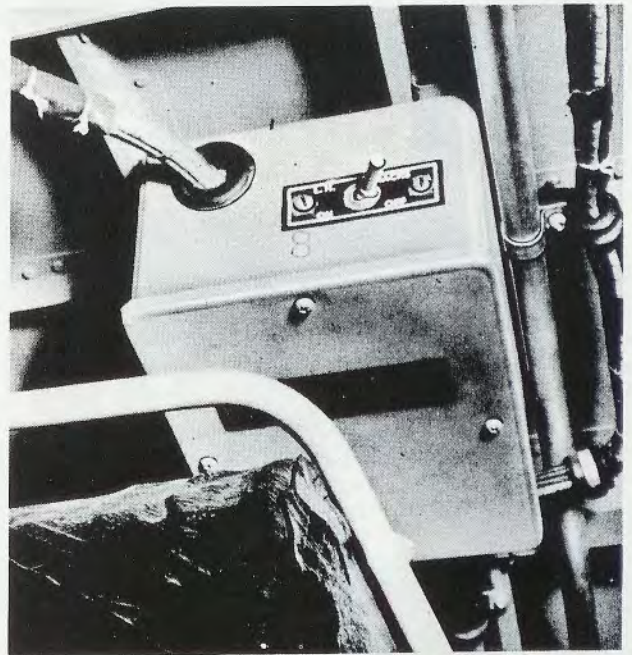

Figure 57 - Bomb Rack Selector Switch - Left Side

d. For use of emergency equipment, refer to section III.

4. BOMB RACK SELECTOR SWITCHES.

Two switches, one on each side of the bomb bay, are used in conjunction with the rack selector switches on the bombardier's control panel. When either switch is "OFF," electrical release of bombs or fuel tanks from that rack is impossible.

5. HAND TRANSFER OR REFUELING PUMP.

A hand pump mounted on the aft bulkhead of the bomb bay may be used to transfer fuel in case of electrical power failure or may be attached to a main landing gear shock strut and used as a refueling pump. (See figure 60.)

6. AUXILIARY WING FUEL CELL SHUT-OFF VALVES.

Remote control handles, operating shut-off valves in the lines from each group of outer wing fuel cells, are mounted below the door at the aft end of the bomb bay. Refer to section I, paragraph 4., for operating instructions.

NOTE

In some installations these valve controls are in the radio compartment.

7. RELIEF TUBE.

A relief tube is located behind the dome light in the left bomb bay.

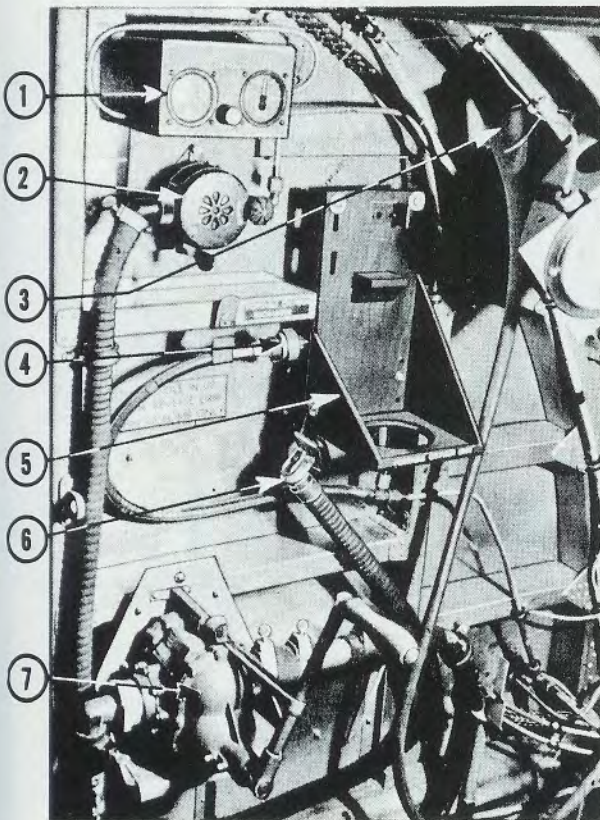

Figure 58 - Bomb Bay - Left Side, Aft

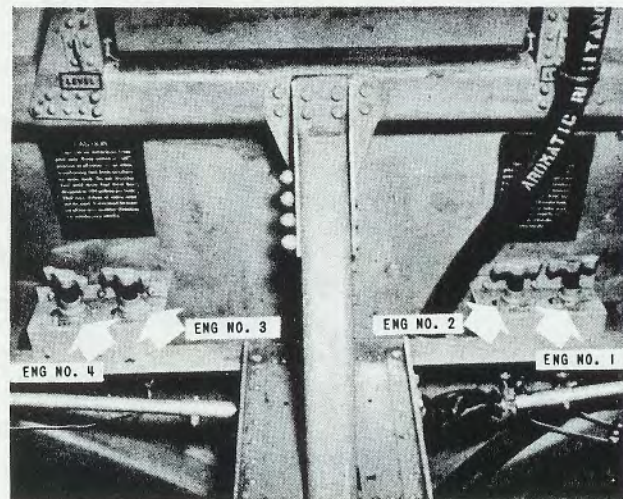

Figure 59 - Auxiliary Fuel Tank Shut-Off Valves

KEY TO FIGURE 58

- | | |
|-----------------------------------|---|
| 1. OXYGEN INDICATOR PANEL | 5. PORTABLE OXYGEN UNIT STORAGE BRACKET |
| 2. OXYGEN REGULATOR | 6. OXYGEN MASK CONNECTION |
| 3. RELIEF TUBE | 7. HAND FUEL PUMP |
| 4. PORTABLE OXYGEN UNIT RECHARGER | |

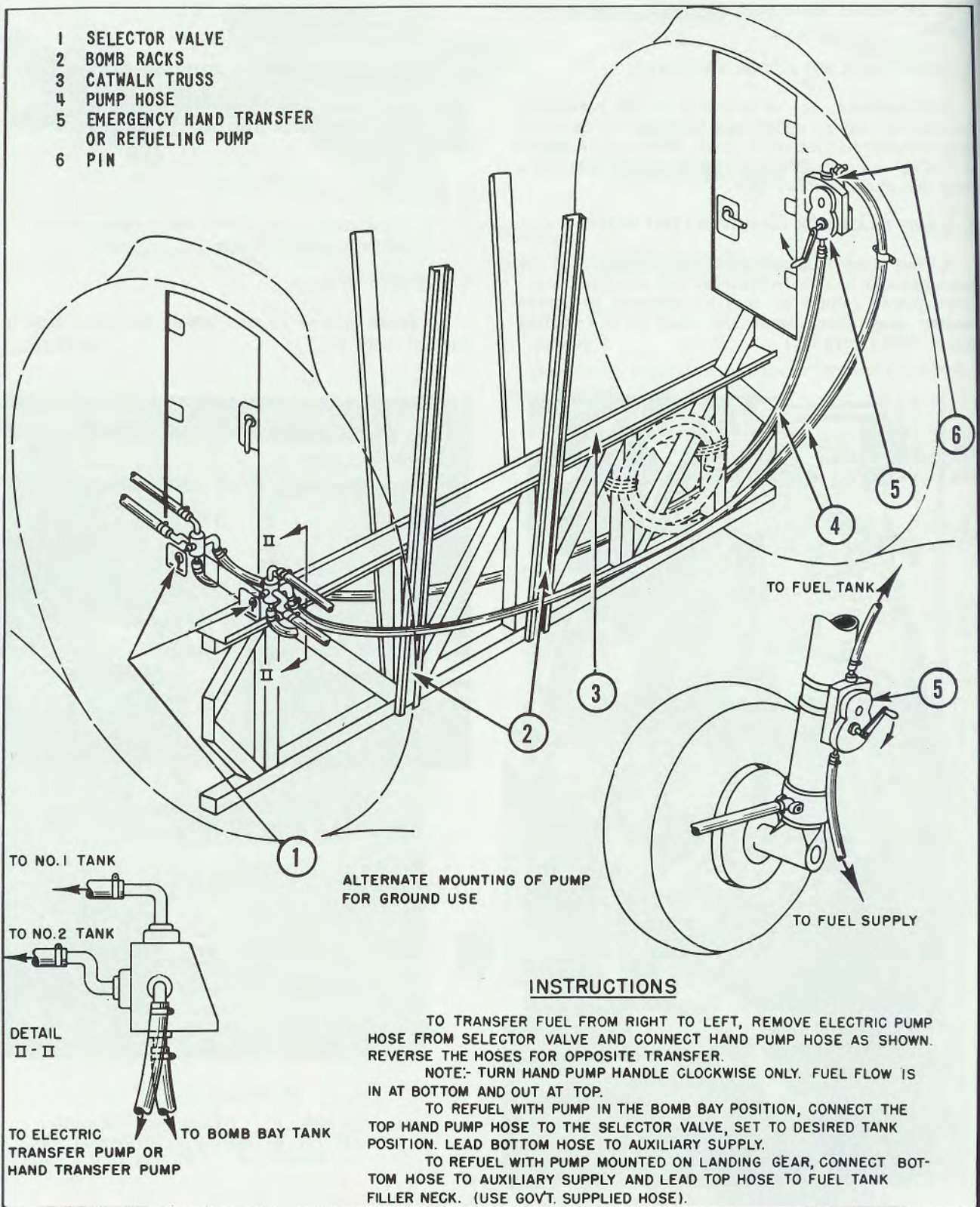
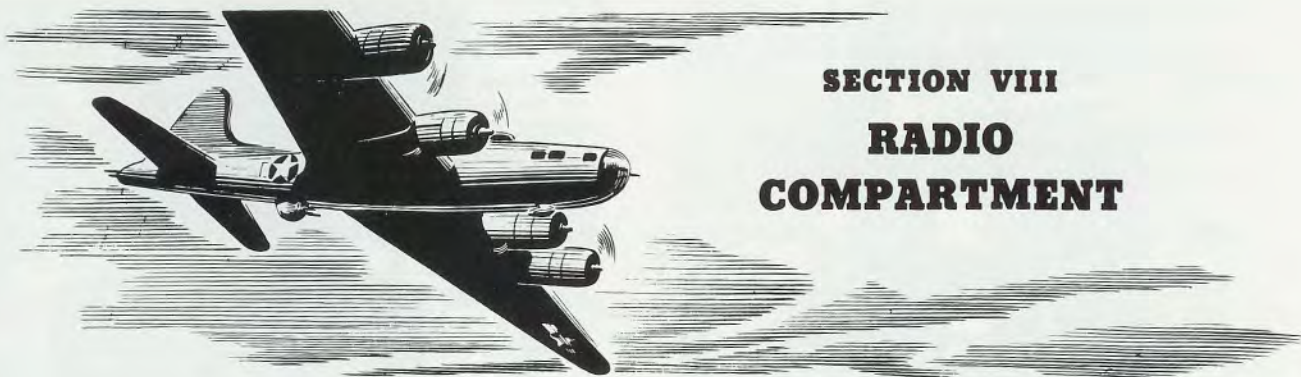
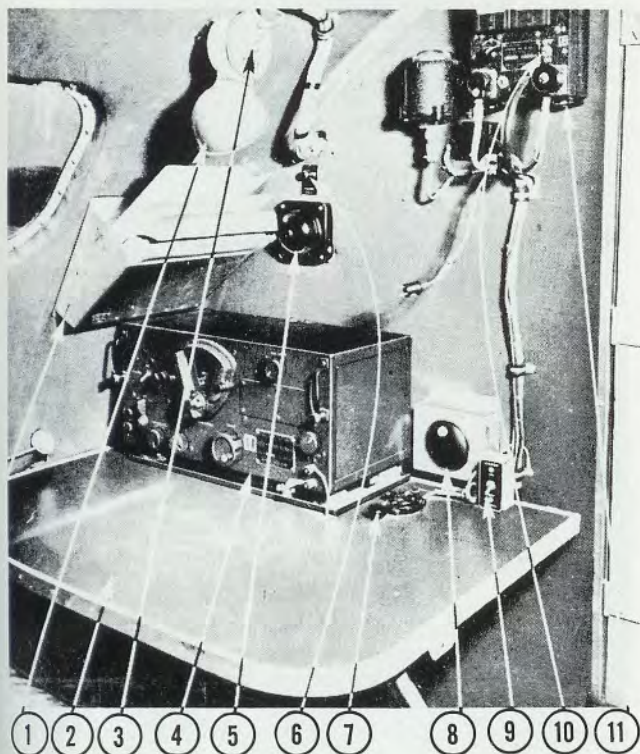

Figure 60 - Hand Fuel Pump Operation



SECTION VIII RADIO COMPARTMENT



KEY TO FIGURE 61

- | | |
|---------------------------|--------------------------------------|
| 1. RADIO OPERATOR'S LIGHT | 8. ASH RECEIVER |
| 2. RADIO OPERATOR'S TABLE | 9. LIAISON TRANSMITTER MASTER SWITCH |
| 3. LIGHT SWITCH | 10. LOCAL "OFF-ON" SWITCH SCR-535 |
| 4. LIAISON SET RECEIVER | 11. RADIO SET SCR-535 CONTROL BOX |
| 5. ALARM BELL | |
| 6. PHONE CALL LAMP | |
| 7. TRANSMITTING KEY | |

Figure 61 - Radio Operator's Table and Controls

1. LIGHTING.

A lamp above the radio operator's table is operated by an adjacent switch. A similar lamp and switch

are in the aft end of the compartment above the liaison transmitter. Another lamp and switch are on the side wall to the left of the radio operator's seat.

2. EMERGENCY EQUIPMENT.

a. A fire extinguisher is on the forward wall of the compartment to the right of the door.

b. Two life raft release handles are on the ceiling of the compartment, just aft of the top hatch on the right side.

c. Four red emergency release handles are located along the edge of the top hatch.

d. An alarm bell is on the forward wall of the compartment above the radio operator's table.

e. Two hand cranks and two crank extensions for manual operation of the wing flaps, bomb bay doors, landing gear, tail gear, and engine starters are clipped to the aft wall of the compartment, above the transmitter tuning units. For use of hand cranks refer to section III.

3. OXYGEN CONTROLS.

Oxygen outlets are provided for the radio operator and for each of the two auxiliary crew members. Refer to section I, paragraph 9., for instructions.

4. HEATING AND VENTILATING INLET.

The inlet is on the floor of the compartment, to the left and aft of the radio operator's seat. Push the knob to close; pull, to open. Selection of hot or cold air is controlled by the pilot.

5. INTERPHONE CONTROLS.

The radio operator's interphone jack box is on the left side wall. Two additional jack boxes are provided in the compartment for other crew members. Refer to section I, paragraph 10., for instructions.

6. COMMUNICATIONS EQUIPMENT.

a. The communications equipment consists of the following:

Command set	SCR-274-N
Liaison set	SCR-287-A
Radio compass set	SCR-269-G
Interphone equipment	RC-36
Marker beacon equipment	RC-43
Radio altimeter	SCR-518-A
IFF radio set	SCR-535-A

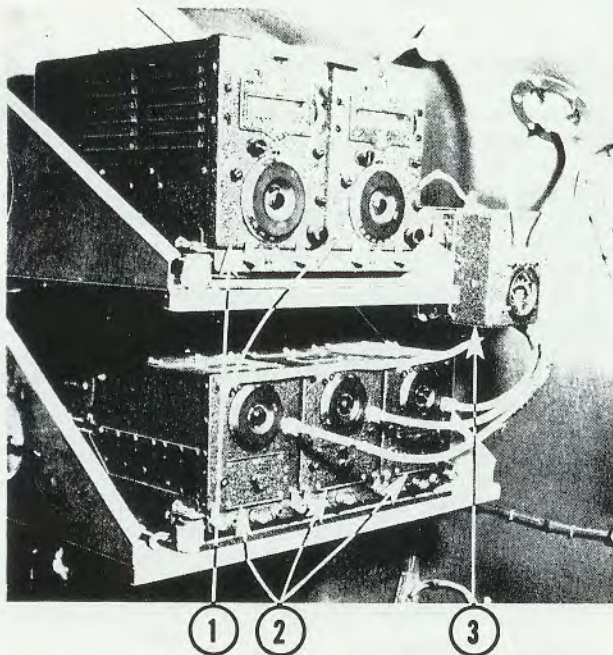

KEY TO FIGURE 62

1. COMMAND TRANSMITTERS
2. COMMAND RECEIVERS
3. ANTENNA RELAY CONTROL BOX

Figure 62 - Command Radio Installation

b. **COMMAND RADIO.** - Two command radio transmitters and three receivers are mounted on the right side of the compartment on the forward bulkhead. They are controlled by remote control units on the ceiling of the pilot's compartment. The transmitters' dynamotor and modulator are on the floor in the forward right corner of the compartment. The receiver's dynamotors are mounted on supports behind the receivers.

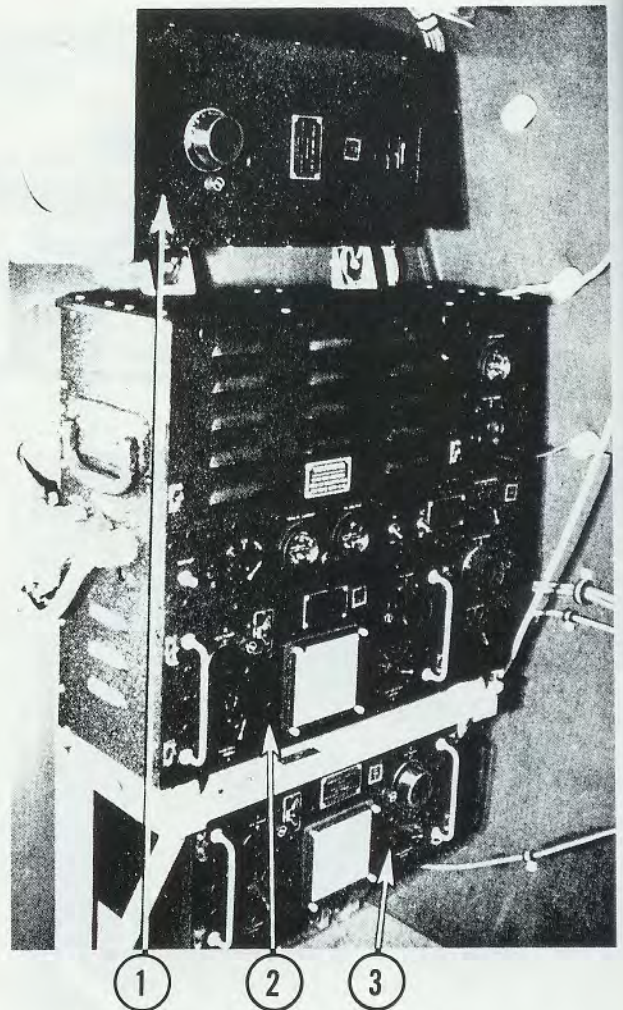

KEY TO FIGURE 63

1. LIAISON ANTENNA TUNING UNIT
2. LIAISON TRANSMITTER
3. TRANSMITTER TUNING UNIT

Figure 63 - Liaison Radio Installation

c. **LIAISON RADIO.** - The liaison transmitter is installed on the left side of the aft bulkhead. The receiver is on the radio operator's table. The dynamotor is on the left rear side of the aft bulkhead, in the ball turret compartment. Two antennas are available for use with the liaison set. One employs the skin of the airplane, with the lead-in attached to the change-over switch on the left side wall. The other is the trailing antenna which is also attached to the change-over switch. The trailing antenna reel is operated electrically from a control box to the right of the change-over switch.

d. **RADIO SET, SCR-518-A (HIGH-ALTITUDE ALTIMETER).** - Radio set SCR-518-A consists of a

complete set of apparatus for determining the height of the airplane above the ground. It is operative over an altitude range of 0 to 20,000 feet, and it will work satisfactorily up to 30,000 feet, before the indications become erroneous. Operation of the set does not depend upon barometric pressure. It indicates altitude of the aircraft above the terrain below the airplane, and has no reference to sea level. If the aircraft is flying over broken country, more than one peak will appear on the indicator, the highest one representing the object closest to the airplane.

(1) Place the power switch in the "ON" position. This energizes all parts of the set except the automatic volume control which is controlled by a separate switch. A pilot lamp at the lower center of the control panel should light, indicating that the power is on.

(2) As the tubes reach their operating conditions, the circle traces, and indicating lobes appear on the screen of the indicator. During the first few minutes of operations the indications will be unsteady.

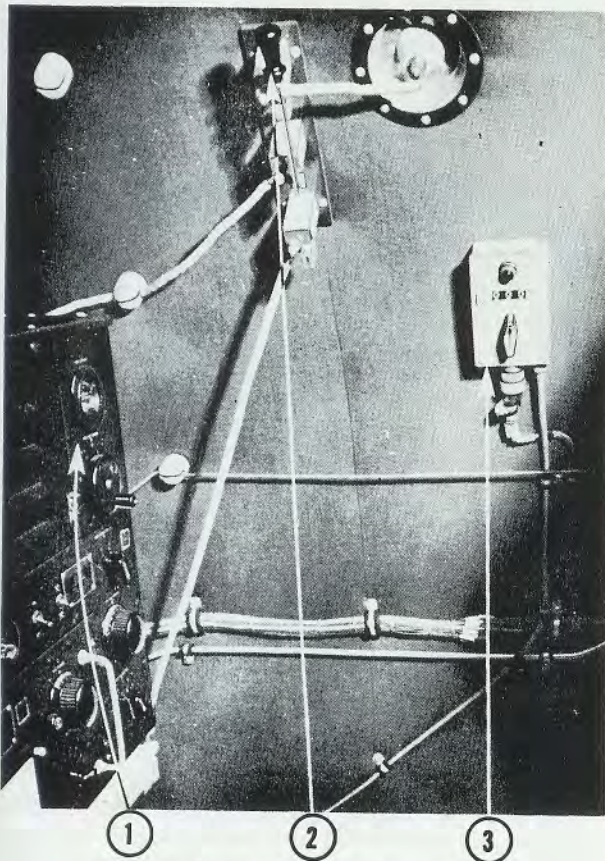

KEY TO FIGURE 64
 1. LIAISON TRANSMITTER
 2. ANTENNA CHANGE-OVER SWITCH
 3. TRAILING ANTENNA REEL CONTROL

Figure 64 - Radio Compartment - Left Side

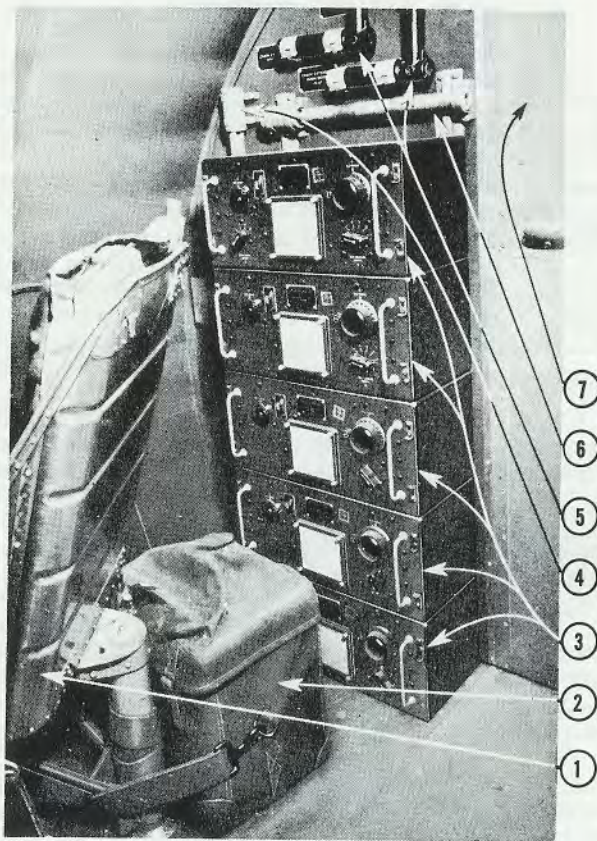

KEY TO FIGURE 65

- | | |
|-----------------------------|---|
| 1. SEAT FOR AUXILIARY CREW | 5. HAND CRANKS |
| 2. FREQUENCY METER | 6. CRANK EXTENSION FOR BOMB DOORS AND FLAPS |
| 3. TRANSMITTER TUNING UNITS | 7. DOOR TO BALL TURRET COMPARTMENT |
| 4. STARTER CRANK EXTENSION | |

Figure 65 - Transmitter Tuning Units

(3) Turn the "CIRCLE SIZE" control knob until the two circle traces on the indicator screen are adjusted to the required diameter for readings. The proper size occurs when each circle is just visible as a luminous green ring on the gray background, just beyond the outer circumference of its dark calibrated scale ring.

(4) Turn the "RECEIVER GAIN" control to adjust the lobe readings for clearest legibility on the indicator screen. Maximum receiver sensitivity may be used at the higher altitudes and less than maximum sensitivity may be required at the lower altitudes. The receiver gain control must be adjusted in conjunction with the automatic volume control switch for maximum lobe legibility on the altimeter scale in accordance with the following paragraphs.

(5) USE OF AUTOMATIC VOLUME CONTROL AT LOWER ALTITUDES.

(a) The automatic volume control improves the performance of the radio set at altitudes below 2000 feet and should only be used for reading up to 2000 feet. With the AVC switch on, receiver sensitivity is reduced but is automatically increased with altitude up to about 2000 feet. Overloading of the receiver is thus prevented at the lower altitudes.

(b) For operation when descending below 2000 feet:

1. At any altitude above 1000 feet, throw AVC switch on.

2. Adjust "RECEIVER GAIN" control until the initial lobe appearing at zero on the 2000-foot scale is the proper height.

3. The reception lobe giving the altitude reading on the 2000-foot scale should now remain approximately constant in size as the ground is approached.

(6) USE OF AVC AT HIGHER ALTITUDES. - The AVC switch must be turned off, when the equipment is operating at altitudes above 2000 feet, as the AVC would otherwise impair the receiver sensitivity in certain sections of the higher-altitude ranges.

(7) Starting from zero and reading in a clockwise direction, read the counterclockwise edge of each lobe on each circle trace. (If the lobe is on the top of the dial, read to the left edge, and if it is at the bottom of the dial, read the right edge.) The first lobe (or index lobe) appears at the zero calibration on each scale. The second lobe (reflection lobe) indicates the altitude above terrain.

(a) On each scale (inner and outer), the index lobe will appear at the zero calibration. The second (reflection lobe) on each scale indicates the absolute altitude of the aircraft.

(b) The inner circle is merely a vernier on the outer circle. On the outer circle, it is possible to read to within 250 feet. If greater accuracy is required, the inner scale reading must be taken into consideration, as follows: Read the outer scale to the next lower even thousand (4000, for instance). Read the inner scale. If the reading of the inner scale should be 750 feet, the actual altitude of the aircraft is then obtained by adding the readings of the two scales: 4750 feet. The inner scale can, with practice, be read to within 25 feet.

(c) If the zero lobes have shifted away from zero, correct readings may be obtained by adding the amount of zero shift, if the shift is to the left of zero, and by subtracting the amount of zero shift, if the shift is to the right, from the reading of altitude which was obtained by following the procedure outlined in the preceding paragraph.

7. FREQUENCY METER.

A portable frequency meter for use with any radio is carried in each airplane. No provision is made for stowage, so the unit is usually strapped to the support of the rear auxiliary seat in the radio compartment.

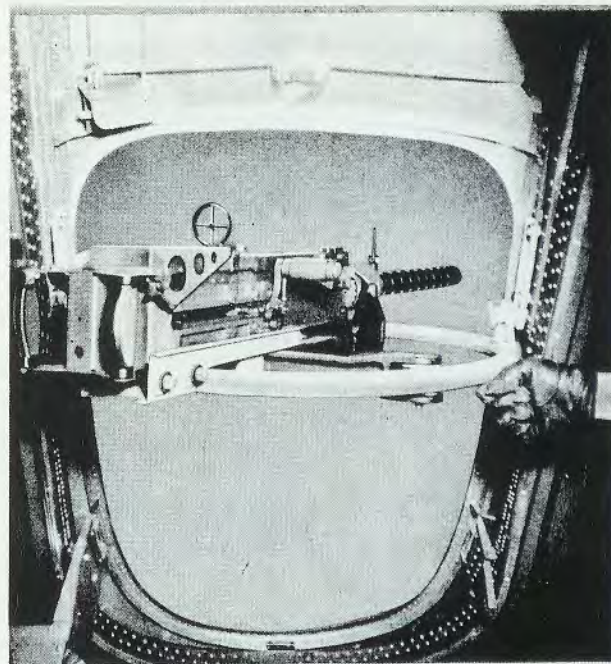
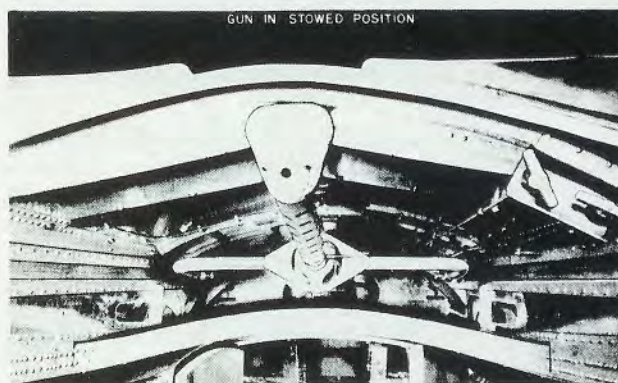

Figure 66 - Radio Compartment Gun

8. RADIO COMPARTMENT GUN.

In some airplanes a single .50-caliber flexible machine gun is mounted on a yoke in top of the radio compartment to fire through the top hatch opening. The yoke slides on rails from stowed to firing position.

9. CAMERA PIT.

a. Camera equipment is installed in the pit under the floor of the radio compartment accessible door.

Provision is made for three alternate installations as follows:

Type T-3A Installation:

Camera	Type T-3A
Camera mount	A-5A
View finder	A-2
Filter	A-3
Shutter induction coil	

Type K-3B Installation:

Camera	Type K-3B
Camera mount	A-8
View finder	A-2
Intervalometer	
Magazine	A-1A
Filter	A-2A

Type K-7C Installation:

Camera	Type K-7C
Camera mount	A-8
View finder	A-2
Filter	A-4

b. The type A-2 view finder may be installed forward of the camera. The bracket assembly used to support the intervalometer is stowed on the right side of the camera pit. The intervalometer is stowed on the right side. A direct current power receptacle for the intervalometer is installed on the right side of the pit and a connection to the vacuum system is provided on the left side.

c. The double camera doors (figure 67) and the view finder door are hinged in the bottom of the fuselage and are operated by a lever located on the floor at the operator's seat.

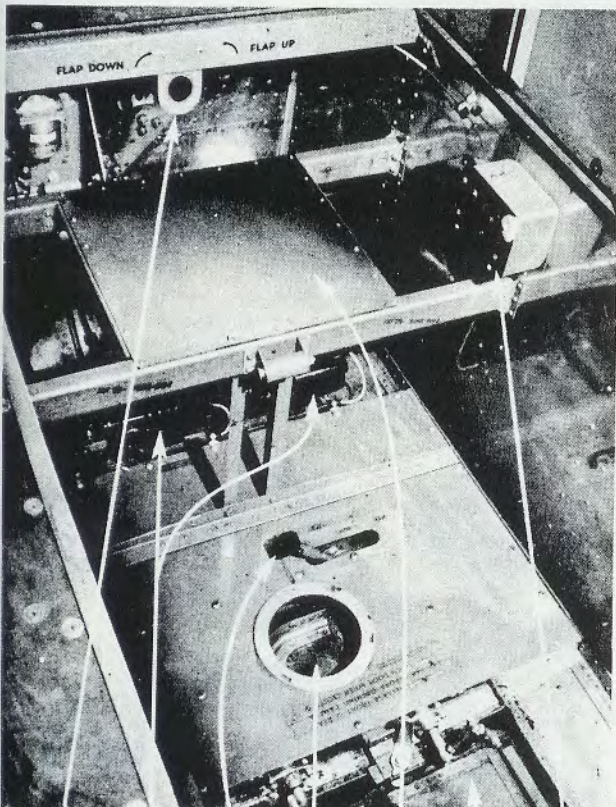

- ①
- ②
- ③
- ④
- ⑤
- ⑥
- ⑦

KEY TO FIGURE 67

- | | |
|------------------------------------|-----------------------------------|
| 1. WING FLAP HAND CRANK CONNECTION | 4. VIEWFINDER APERTURE |
| 2. PROPELLER ANTI-ICER PUMPS | 5. CAMERA OPERATOR'S SEAT |
| 3. CAMERA DOOR CONTROL HANDLE | 6. CAMERA DOOR |
| | 7. INTERVALMETER POWER RECEPTACLE |

Figure 67 - Camera Pit

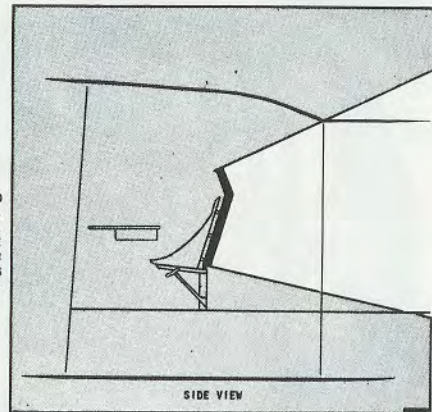

ARMOR PROTECTS RADIO OPERATOR FROM U.S. .30, GERMAN .312, ITALIAN & JAPANESE .303 (7.7 MM) CALIBER FIRE ORIGINATING WITHIN WHITE AREAS.

SIDE VIEW

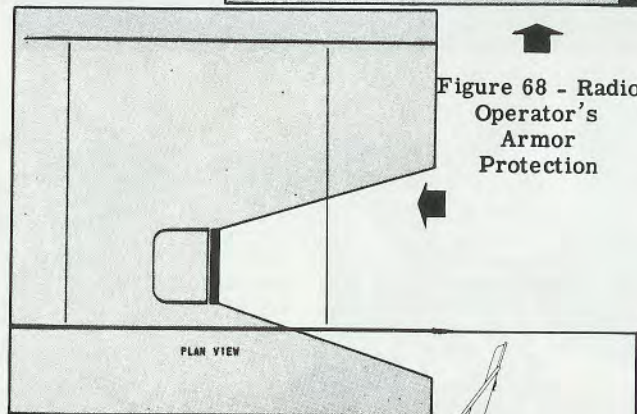

PLAN VIEW

Figure 68 - Radio Operator's Armor Protection

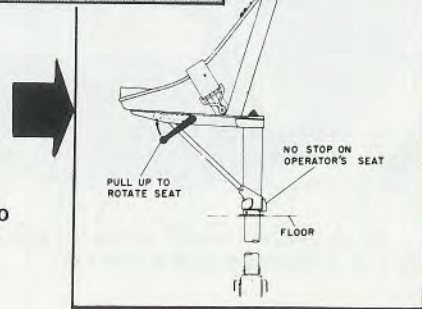
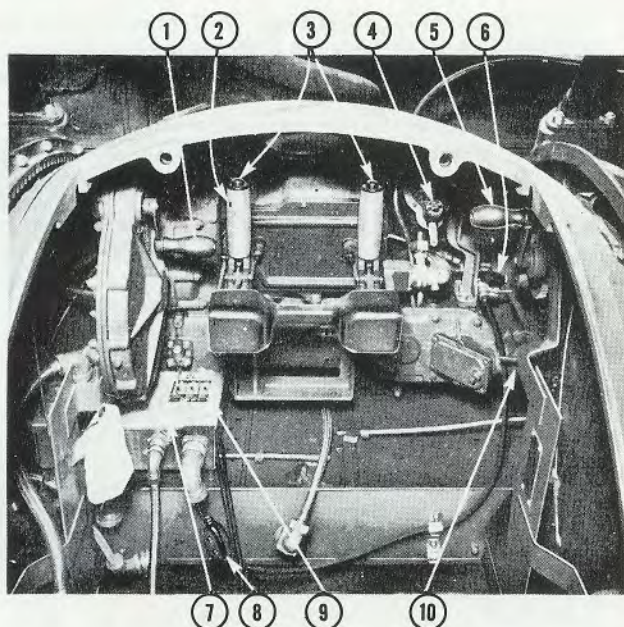

Figure 69 - Radio Operator's Seat Adjustment

SECTION IX BALL TURRET



KEY TO FIGURE 70

- | | |
|------------------------|------------------------------|
| 1. ELEVATION HANDCRANK | 6. SPOT LIGHT |
| 2. HAND CONTROL GRIP | 7. ELECTRICAL SWITCH BOX |
| 3. FIRING SWITCHES | 8. SPOT LIGHT CONTROL SWITCH |
| 4. OXYGEN REGULATOR | 9. GUN SELECTOR SWITCHES |
| 5. AZIMUTH HANDCRANK | 10. ELEVATION POWER CLUTCH |

Figure 70 - Interior of Ball Turret

1. GENERAL.

a. A Sperry ball-type power turret, equipped with twin .50-caliber machine guns, is installed in the bottom of the fuselage aft of the radio compartment.

b. A hydraulic unit provides power for driving the turret in azimuth and elevation.

c. The hand control and limit unit controls the outputs of the azimuth and elevation hydraulic systems. A pair of handgrips controls the motion of the turret in azimuth and elevation. Each handgrip has a firing switch on the top end.

d. The switch box controls distribution of the electric power to the various units in the turret. The terminal block in the top left end of the box has convenient posts for connecting the leads of the gunner's head set and microphone.

2. ENTERING THE TURRET.

CAUTION

Do not attempt to rotate the turret in elevation while the airplane is on the ground. No crew member shall be in the turret during landing or take-off and the guns of the turret shall be in the horizontal position pointing aft.

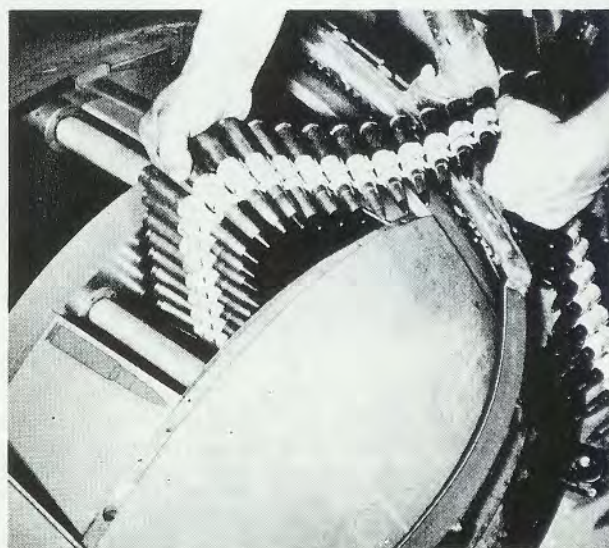
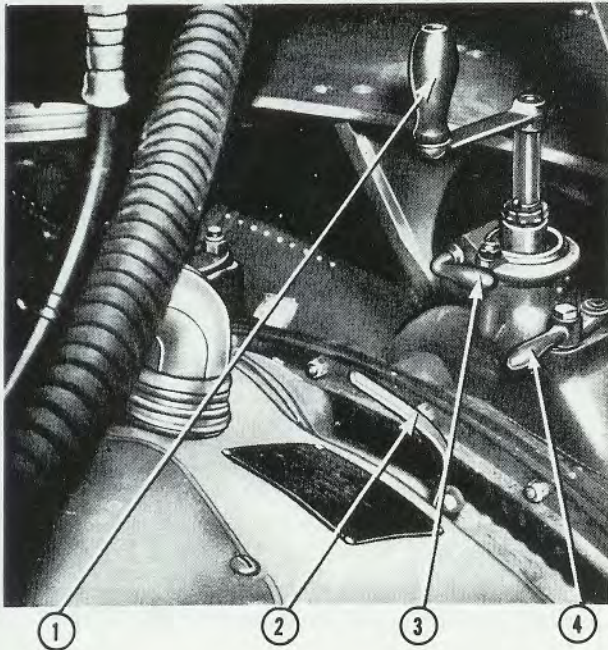

Figure 71 - Loading Ball Turret Ammunition Boxes



KEY TO FIGURE 72

- | | |
|-------------------------|--------------------------|
| 1 - ELEVATION HANDCRANK | 3 - ELEVATION HANDBRAKE |
| 2 - LUG WRENCH | 4 - ELEVATION HANDCLUTCH |

Figure 72 - External Manual Controls

a. Remove ammunition box cover and load. Push ammunition down to the guns.

b. Remove elevation hand crank from its clip and attach it to shaft. Be sure that the hand brake (figure 72) is locked.

c. Move elevation hand clutch to "IN" position. It may be necessary to loosen hand brake and rock hand crank back and forth before hand clutch can be moved to "IN" position.

d. Move elevation power clutch to "OUT" position using clutch handle; then, replace handle in its clip.

e. Loosen elevation brake slowly while holding elevation hand crank firmly.

f. Turn elevation hand crank in down direction until turret revolves to low limit of elevation (-90 degrees).

g. While holding elevation hand crank, open turret door, reach inside, and move elevation power clutch to "IN" position.

h. Move elevation hand clutch to "OUT" position, remove hand crank, and replace it in its clip.

i. Enter turret. Close door securely. Be sure door handles are pushed all the way up and that the

KEY TO FIGURE 73

1. ELECTRICAL SWITCH BOX
2. SPOT LIGHT SWITCH
3. GUNNER'S SEAT
4. RANGE FOOT PEDAL
5. HEADSET AND MICROPHONE LEADS
6. TURRET FRONT WINDOW
7. FOOT REST
8. CHARGING HANDLE
9. TURRET HAND CONTROL AND LIMIT UNIT
10. ELEVATOR POWER CLUTCH

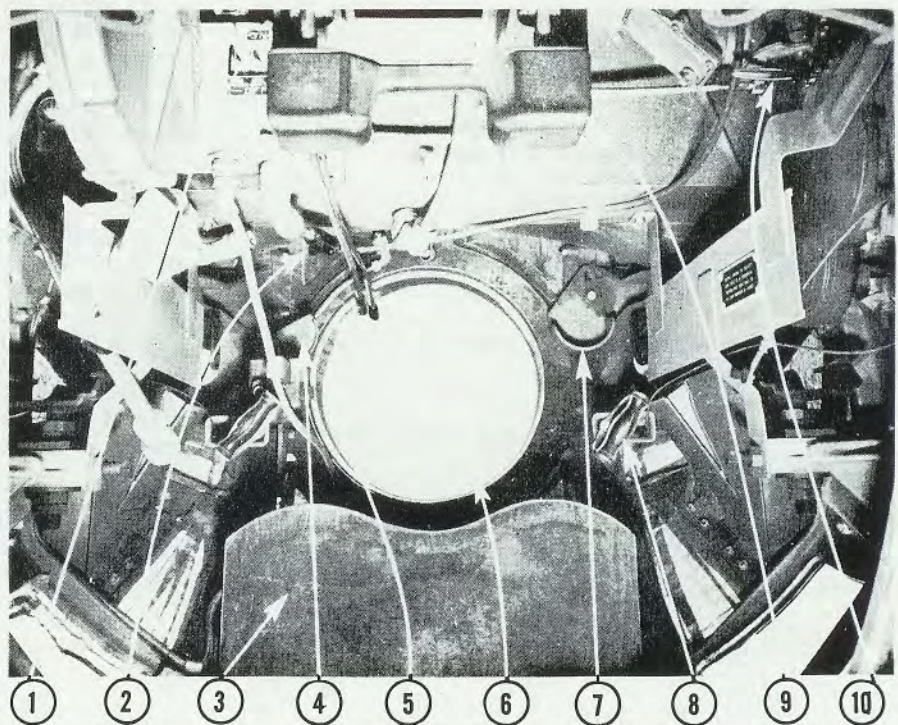

Figure 73
Ball Turret, Top View



Figure 74 - Inside Ball Turret

turret door is locked before turning main power and sight switches "ON."

3. PREFLIGHT CHECK.

- a. Turn power switch "ON."
- b. Turn sight switch "ON."
- c. Check response of azimuth and elevation mechanisms by manipulating the hand controls.

WARNING

Be sure that the guns are not driven down into the ground.

- d. Adjust reticle light on sight to desired brilliance (approximately).
- e. Work range foot pedal and observe if reticles move in response.
- f. Lift each gun cover plate and pull ammunition down, feeding first shell by hand into magazine of gun; then, close gun cover plates.

4. OPERATION.

- a. Load ammunition boxes. (See figure 71.) Enter turret.
- b. Turn on power switch.
- c. Turn on sight switch.
- d. Charge guns by pulling charging handles twice.
- e. Turn on fire selector switches.
- f. By means of hand controls track the target.
- g. Operate range foot pedal until reticles frame the target.
- h. Close either firing key.
- i. When ammunition is used up, charge guns at least twice to be sure that no live shells are left in the guns.

5. INTERPHONE.

A press-to-talk switch for inter-communication is located just in front of the gunner's right footrest.

6. SUIT HEATER.

A rheostat control is provided for use with the gunner's heated suit. It is located on the underneath side of the seat and is adjusted to obtain the desired temperature in the suit.

7. OXYGEN.

An oxygen regulator is provided on the inside of the ball turret on the right side. Refer to section VI, paragraph 4.c., for operation. Oxygen is supplied from the auxiliary cylinder above the turret. When the supply of this auxiliary cylinder is exhausted, it can be renewed from the airplane's main supply system.

8. ADJACENT EQUIPMENT.

- a. LIGHTING. - A dome light in the ceiling just aft of the turret support is operated by a switch to the right of the door to the radio compartment.
- b. EMERGENCY RADIO - SCR 578. - Some airplanes are provided with a completely independent emergency radio which is carried on the right rear side of bulkhead 6 beside the ball turret. Refer to section III, paragraph 14., for further instructions.
- c. FIRST-AID KIT. - A first-aid kit is clipped to the aft side of the bulkhead between the ball turret compartment and the radio compartment to the left of the door.

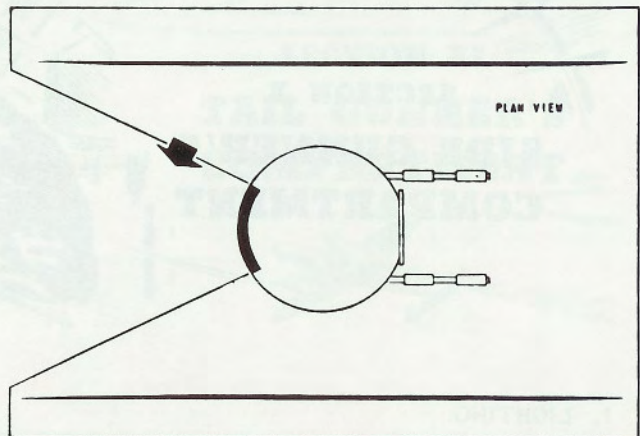
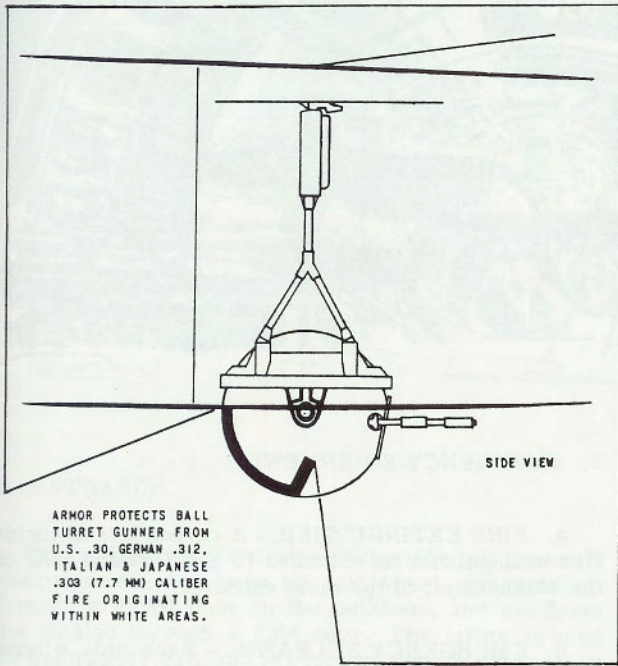

Figure 75
Ball Turret Gunner's
Armor Protection

SECTION X SIDE GUNNER'S COMPARTMENT



1. LIGHTING.

The dome light switch is aft of the entrance door.

2. INTERPHONE CONTROLS.

Interphone jack boxes are provided for both gunners. Refer to section I, paragraph 10., for operation.

3. SUIT HEATER OUTLET.

Rheostats control the temperature of the gunners' heated suits. They are adjusted to obtain the desired temperature in the suits.

4. OXYGEN.

Oxygen regulators and portable oxygen units are provided for each side gunner. Refer to section I, paragraph 9., for instructions.

5. EMERGENCY EQUIPMENT.

a. FIRE EXTINGUISHER. - A carbon tetrachloride fire extinguisher is attached to the forward side of the bulkhead aft of the main entrance.

b. EMERGENCY RELEASES. - Each side window has an emergency release bar on the forward side of each window. To open the window, jerk the bar forward. There are no catches to be released. The main entrance door also has an emergency release handle.

6. GUN OPERATION.

To prepare the machine guns for action, remove the straps (figures 76 and 77) and swing the guns into position.

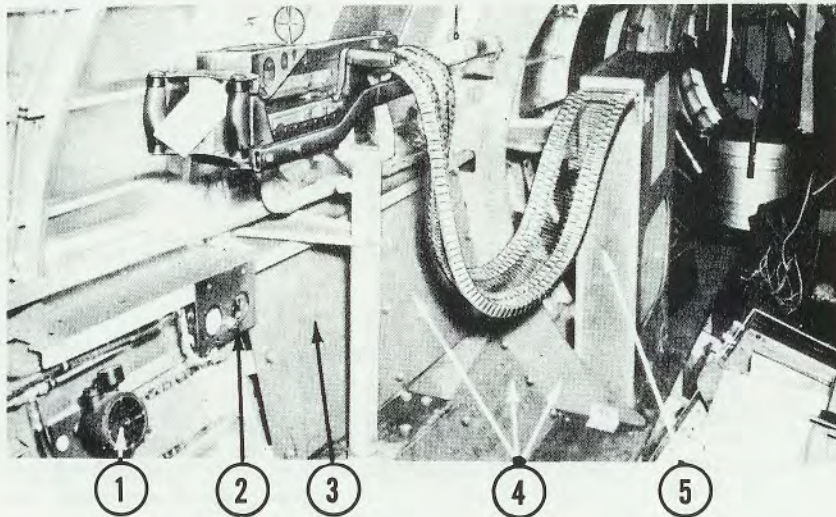

KEY TO FIGURE 76

1. PORTABLE OXYGEN UNIT 2. OXYGEN INDICATOR PANEL 3. MACHINE GUN, STOWED
4. ARMOR PLATE 5. AMMUNITION BOX

Figure 76 - Right Side Gun Stowed

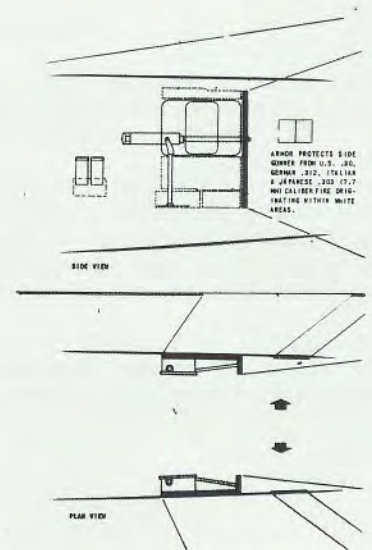
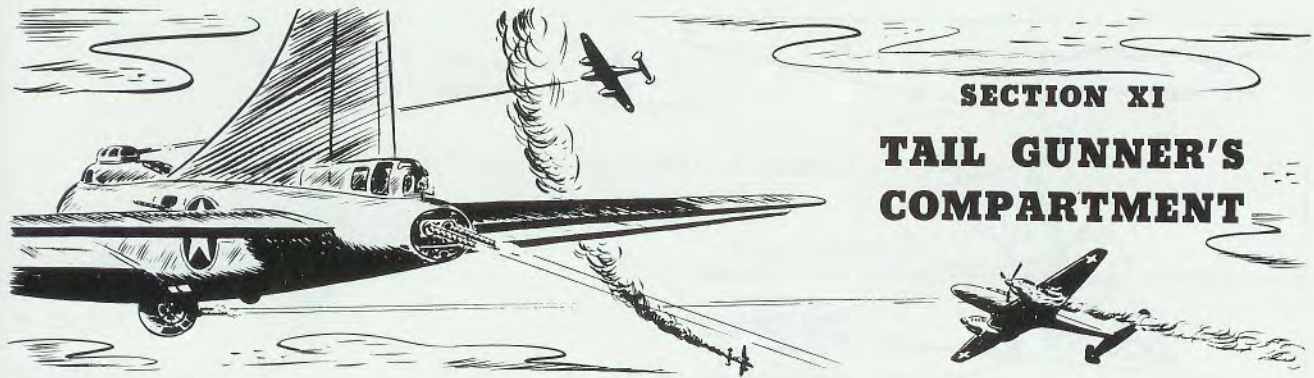

Figure 77 - Side Gunner's
Armor Protection



SECTION XI TAIL GUNNER'S COMPARTMENT

1. ENTRANCE.

There are two ways of entering the tail gunner's compartment: one from the tail wheel compartment through a small door in the bulkhead, and one from the outside through a side door. The latter is used for emergency exit, and is equipped with an emergency release handle.

2. LIGHTING.

A dome light and switch are located above the gun handles behind the armor plate.

3. INTERPHONE.

The jack box is on the right side of the compartment looking aft above the aft end of the ammunition box. Refer to section I, paragraph 10.

4. OXYGEN.

Two oxygen regulators are provided, one on each side wall. Refer to section I, paragraph 9.

5. SUIT HEATER OUTLET.

A rheostat control, provided for use with the gunner's heated suit is adjusted to obtain the desired temperature in the suit.

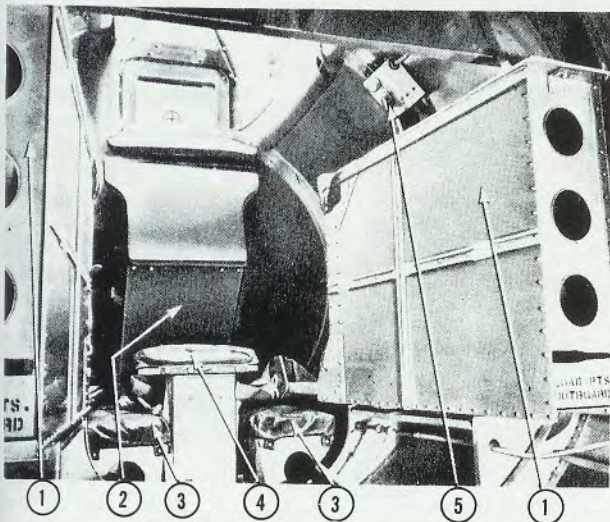

KEY TO FIGURE 78

- | | |
|-----------------------|-----------------------|
| 1. AMMUNITION BOXES | 2. ARMOR PLATE |
| 3. KNEE PADS | 4. TAIL GUNNER'S SEAT |
| 5. INTERPHONE JACKBOX | |



Figure 78 - Tail Gunner's
Compartment



Figure 79 - Tail Gunner's
Compartment Door

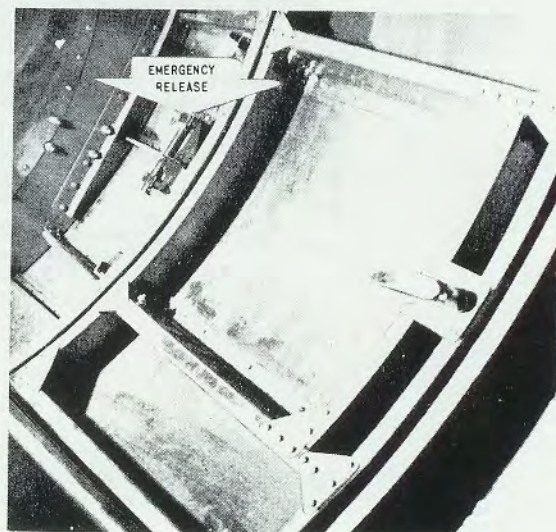

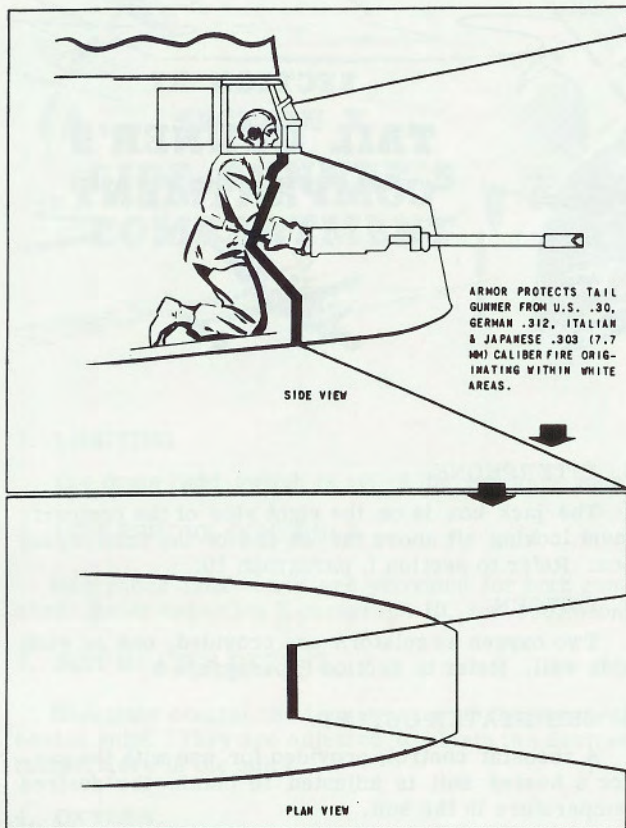
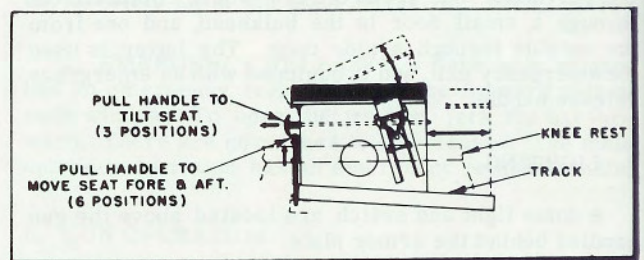

Figure 80 - Tail Gunner's
Armor Protection



Figure 81 - Tail Gunner's
Seat Adjustment



FORCED DESCENT AT SEA

19



During preflight drill, men should be assigned to evacuation duties. Each man should be familiar with these so that in case of accident alternate men can carry on. Each man should know his order.

22

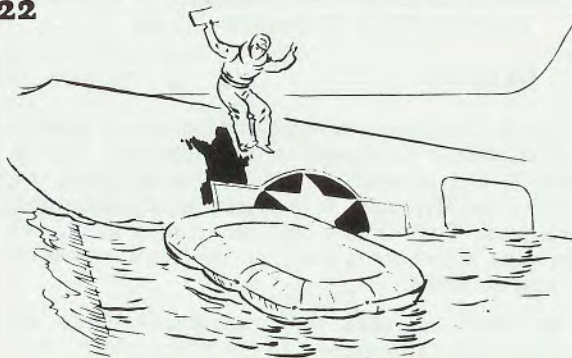

WARNING!

Do not jump on an inverted raft, as this will expel the air trapped under it and righting becomes more difficult.

20



Pilot and copilot will exit through their side windows or through the radio compartment hatch. Decide which before flight.

CAUTION!

No crew member should inflate his life vest until he has emerged from the airplane.

23



The rafts should be fastened together so they will not drift apart. Once aboard the rafts a check should be made to locate leaks. Repair them with the kit provided in the raft. Keep away from the airplane, if it floats but stay in the vicinity if possible. Do not remove wet clothing. Do not talk more than necessary; it dries the mouth. Do not move more than necessary; it takes energy.

21



If the life raft is inflated upside down, one man should jump into the water and right it. If there are handling patches on bottom of raft, grasp them with both hands, and with knees on buoyancy chamber, lean back and prepare to be submerged for a moment. Even the largest raft will turn over.

24

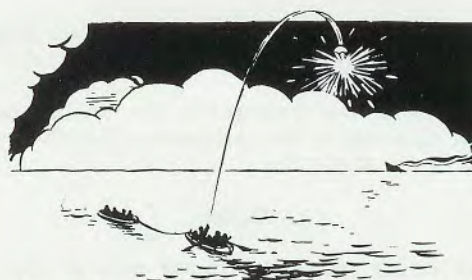

A signal kit containing a pistol and flares is in a waterproof sealed pocket of the life raft. It may be advisable to leave the kit sealed in the pocket until a ship or a plane is sighted so as to have dry signal equipment.

APPENDIX I

U. S. A. - BRITISH GLOSSARY OF NOMENCLATURE

U. S. A	BRITISH
Accumulator (hydraulic)	Should not be confused with electrical accumulator or battery
Airfield	Aerodrome
Battery (electrical)	Electrical accumulator
Bombardier	Bomb aimer
Ceiling	Cloud height
Check valve (hydraulic)	Non-return valve
Copilot	Second pilot
Cylinder (hydraulic)	Jack
Dump valve	Jettison valve
Empennage	Tail Unit
Flight indicator	Artificial horizon
Gasoline (gas)	Petrol
Glass, bulletproof	Armour glass
Gross weight	All-up weight
Ground (electrical)	Earth
Gyro horizon	Artificial horizon
Gyro pilot	Automatic pilot
(to) Land	(to) Alight
Lean	Weak
Left	Port
(to) Level off	(to) Flatten out
Line, mooring	Mooring guy
Manifold pressure	Boost
Mast, radio	Rod aerial
Overload	Non-standard load
Panel, outboard	Outer plane
Reticule (gun sight)	Graticule
Screen	Filter
Set, command	Pilot controller set
Set, liaison	General purpose set
Airplane	Aircraft
Speed, indicated air (IAS)	Air-speed-indicator reading
Stabilizer, horizontal	Tail plane
Stabilizer, vertical	Fin
Stack	Manifold (inlet or exhaust)
Tachometer	Engine speed indicator
Tube (radio)	Valve
Turn indicator	Direction indicator
Valve (fuel or oil)	Cock
Weight empty	Tare
Windshield	Windscreen
Wing	Main plane



APPENDIX II
FLIGHT OPERATION DATA

Chart	Page
Specific Engine Flight Chart	79
Take-Off, Climb and Landing Chart	80
Flight Operation Chart (no external load) 7 Sheets	81
Flight Operation Chart (external load - two 2000- pound bombs) 3 Sheets	88
Flight Operation Chart (external load - two 4000- pound bombs) 2 Sheets	91
Flight Operation Chart (one propeller feathered) 4 Sheets	93
Engine Flight Calibration Curve	97
Loading Chart	98
Take-Off Control Chart	99
Climb Control Chart	100
Composite Cruising Control Chart	101
Tactical Range Charts	102
Ferry Range Charts	104
Long Range Cruise Control Charts	105
Fuel Temperature Correction Curve	107
Fuel Consumption Curve	108

CAUTION

POWER SETTINGS GIVEN IN THESE CHARTS ARE APPLICABLE ONLY WHEN USING 100 OCTANE FUEL. REFER TO APPENDIX III FOR RESTRICTIONS WITH USE OF 91 OCTANE FUEL.

AIRPLANE MODELS
B-17 F

SPECIFIC ENGINE
FLIGHT CHART

ENGINE MODELS
R-1820-97

FORM 55C512A

CONDITION	FUEL PRESSURE (LB./SQ. IN.)	OIL PRESSURE (LB./SQ. IN.)	OIL TEMP.		COOLANT TEMP.		MAX. PERMISSIBLE DIVING RPM: 2760
			°C	°F	°C	°F	
DESIRED	12-16	75	70	158			ALLOWABLE OIL CONSUMPTION
MAXIMUM	16	80	88	190			NORMAL RATED (MAX. CONT.) 14.5 U.S.QT./HR. 23 IMP.PT./HR.
MINIMUM	12	70					MAX. CRUISE 8.0 U.S.QT./HR. 13 IMP.PT./HR.
IDLING		15					MIN. SPECIFIC 5 U.S.QT./HR. 8 IMP.PT./HR.
							OIL GRADE: (S) 1120 (W) 1100-A

OPERATING CONDITION	RPM	MANIFOLD PRESSURE (BOOST)	HORSE-POWER	CRITICAL ALTITUDE		USE LOW BLOWER BELOW:	MIXTURE CONTROL POSITION	FUEL FLOW (GAL./HR./ENG.)		MIXTURE CONTROL POSITION	MAXIMUM CYL. TEMP. °C	MAXIMUM CYL. TEMP. °F	MAXIMUM DURATION (MINUTES)
				WITH RAM	NO RAM			U.S.	IMP.				
TAKE-OFF	2500	46	1200	27,000		-	A. R.	152	127	A. R.	260	500	5
WAR EMERGENCY													
MILITARY	2500	46*	1200	27,000		-	A. R.	152	127	A. R.	260	500	5
NORMAL RATED (MAX. CONT.)	2300	41.5*	1000	30,000		-	A. R.	103	86	A. R.	232 CLIMB 218	450 CLIMB 424	
MAXIMUM CRUISE	2000	35.2*	750	35,000			A. L.	62.5	52	A. L.	205	401	
MINIMUM SPECIFIC CONSUMPTION	2000 1940 1780 1700 1600 1400	34.7 33.0 36.0 35.5 34.8 32.5	670 600 650 600 550 450	SEE ENGINE CALIBRATION CURVE			A. L.	52 44 45.5 41.5 37.8 31.2	43 37 38 34.6 31.4 26		205	401	

REMARKS: AIR INTAKE FILTER MUST BE OFF ABOVE 8000 FEET OR DANGEROUS TURBO OVERSPEEDING WILL RESULT. FULL THROTTLE MUST BE USED ABOVE 15,000 FEET OR DANGEROUS TURBO OVERSPEEDING WILL RESULT. DO NOT MANUALLY LEAN. AUTO LEAN GIVES MAXIMUM RANGE. *DECREASE MANIFOLD PRESSURES 1-1/2 INCH PER 1000 FEET ABOVE CRITICAL ALTITUDE.

Specific Engine Flight Chart

AIRPLANE MODELS
B-17F

ENGINE MODELS
R-1820-97

TAKE-OFF DISTANCE (IN FEET)

GROSS WEIGHT (IN LBS.)	HEAD WIND				HARD SURFACE RUNWAY				SOD-TURF RUNWAY				SOFT SURFACE RUNWAY						
	AT SEA LEVEL		AT 3,000 FT.		AT 6,000 FT.		AT SEA LEVEL		AT 3,000 FT.		AT 6,000 FT.		AT SEA LEVEL		AT 3,000 FT.		AT 6,000 FT.		
	MPH	KNOTS	GROUND RUN	TO CLEAR 50' OB.	GROUND RUN	TO CLEAR 50' OB.	GROUND RUN	TO CLEAR 50' OB.	GROUND RUN	TO CLEAR 50' OB.	GROUND RUN	TO CLEAR 50' OB.	GROUND RUN	TO CLEAR 50' OB.	GROUND RUN	TO CLEAR 50' OB.	GROUND RUN	TO CLEAR 50' OB.	
65,000	0	0	3350	4400	4000	5100	4800	5800	3950	5000	4500	5600	5800	6800	8950	10,000			
	20	37	2300	3200	2750	3700	3250	4300	2500	3600	3150	4100	3850	5000	7100	8000			
	40	75	1400	2050	1750	2500	2250	3080	1850	2600	2150	2900	2600	3600	5350	6000			
57,000	0	0	2350	3000	2700	3400	3100	3900	2650	3300	3100	3800	3600	4400	4350	5000	5500	6200	7000
	20	37	1600	2100	1800	2400	2130	2600	1800	2300	2100	2700	2650	3200	3100	3000	4000	4600	5150
	40	75	1000	1400	1100	1550	1350	1850	1100	1500	1350	1800	1600	2100	2100	2500	2750	3200	3700
50,000	0	0	1700	2250	1900	2500	2100	2780	1850	2400	2100	2700	2350	3000	2650	3200	3200	3800	4300
	20	37	1150	1600	1300	1750	1400	1900	1250	1700	1450	1900	1600	2100	1800	2250	2250	2700	2600
	40	75	650	1000	800	1150	850	1250	750	1100	900	1250	1000	1400	1100	1450	1450	1800	1600

NOTE: INCREASE DISTANCE 10% FOR EACH 10°C ABOVE 0°C (10% FOR EACH 20°F ABOVE 32°F)

ENGINE LIMITS FOR TAKE-OFF 2500 RPM & 46 IN. HG

CLIMB DATA

GROSS WEIGHT IN LBS.	COMBAT MISSIONS USE 2300 RPM & 38 IN. HG				15,000 FT. ALT.				25,000 FT. ALT.				30,000 FT. ALT.					
	TYPE OF CLIMB	S.L. TO S.L. MPH	BEST I.A.S. MPH	TIME FROM S.L. FT./MIN	S.L. U.S.	IMP.	BEST I.A.S. MPH	TIME FROM S.L. FT./MIN	S.L. U.S.	IMP.	BEST I.A.S. MPH	TIME FROM S.L. FT./MIN	S.L. U.S.	IMP.	BEST I.A.S. MPH	TIME FROM S.L. FT./MIN	S.L. U.S.	IMP.
65,000	COMBAT	135	117	575	135	117	400	29	200	167	135	117	140	65	450	375		
	FERRY	135	117	830	135	117	660	20	140	117	135	117	360	39	270	225	135	117
	FERRY	135	117	1060	135	117	890	15	105	87	135	117	600	28	195	162	135	117

FUEL INCLUDES WARM-UP AND TAKE-OFF ALLOWANCE

LANDING DISTANCE (IN FEET)

GROSS WEIGHT IN LBS.	HARD DRY SURFACE				FIRM DRY SOD				WET OR SLIPPERY										
	AT SEA LEVEL		AT 3,000 FT.		AT 6,000 FT.		AT SEA LEVEL		AT 3,000 FT.		AT 6,000 FT.		AT SEA LEVEL		AT 3,000 FT.		AT 6,000 FT.		
	MPH	KNOTS	GROUND RUN	TO CLEAR 50' OB.	GROUND RUN	TO CLEAR 50' OB.	GROUND RUN	TO CLEAR 50' OB.	GROUND RUN	TO CLEAR 50' OB.	GROUND RUN	TO CLEAR 50' OB.	GROUND RUN	TO CLEAR 50' OB.	GROUND RUN	TO CLEAR 50' OB.	GROUND RUN	TO CLEAR 50' OB.	
50,000	110	96	3600	1950	3800	2150	4100	2350	4150	2600	4500	2850	4900	3150	5450	3900	5800	4300	6450

REMARKS

1 I.A.S.: Indicated Air Speed
 2 M.P.H.: Miles Per Hour
 3 S.L.: Sea Level
 4 U.S.: U.S. Gallons
 5 IMP.: Imperial Gallons
 6 NOTE: All Distances are Average
 7 RED FIGURES HAVE NOT BEEN FLIGHT CHECKED

MODEL (S) B-17F		FLIGHT OPERATION INSTRUCTION CHART				EXTERNAL LOAD ITEMS			
FORM ASC-11A		SHEET 7 OF 7 SHEETS				NONE			
GR. WT. 65,000		TO 60,000 POUNDS							
CONDITION	R.P.M.	M.P. (IN. HG.)	BLOWER POSITION	MIXTURE POSITION	DURATION IN MIN.	U.S. G.P.H.	IMP. G.P.H.		
TAKE OFF	2500	46	-	A.R.	5	608	-		
MILITARY POWER	2500	46	-	A.R.	5	608	-		
ENGINE ID	R-1820-9T								
INSTRUCTIONS FOR USING CHART: Select figure in fuel column equal to or less than total amount of fuel in airplanes. Move horizontally to the right or left and select a figure equal to or greater than the air miles to be flown. Vertically below and opposite desired cruising altitude read optimum cruising conditions. NOTES: (A) Avoid continuous climbing in Column 1 in the upper left corner of chart.									
ALTERNATE CRUISING CONDITIONS					NO RESERVE FUEL ALLOWANCE				
I NORMAL RATED (MAX. CONT.)		II		III		IV		V (MAX. RANGE)	
RANGE IN AIR MILES		RANGE IN AIR MILES		RANGE IN AIR MILES		RANGE IN AIR MILES		RANGE IN AIR MILES	
STATUTE	NAUTICAL	STATUTE	NAUTICAL	STATUTE	NAUTICAL	STATUTE	NAUTICAL	STATUTE	NAUTICAL
AT S.L.	AT 25,000	GALLONS NOT AVAILABLE IN FLIGHT							
1810	1660	212 U.S.	1940	2480	2150	2760	2390	3070	2680
1800	1560	1830	2020	2330	2020	2590	2250	2890	2500
1690	1470	1720	1900	2190	1900	2430	2110	2700	2360
1580	1370	1600	1770	2040	1770	2270	1970	2520	2190
1460	1270	1480	1650	1900	1650	2100	1820	2350	2040
1350	1170	1370	1520	1750	1520	1840	1680	2160	1880
1240	1080	1260	1390	1600	1390	1780	1540	1980	1720
1130	980	1150	1270	1460	1270	1620	1410	1810	1570
1010	880	1030	1140	1310	1140	1460	1270	1620	1410
900	780	910	1010	1170	1010	1300	1130	1440	1250
CONTINUED ON SHEET 2									
OPERATING DATA		OPERATING DATA		OPERATING DATA		OPERATING DATA		OPERATING DATA	
R.P.M.	I.A.S. M.P.H.	MIX. TURE (IN. HG.)	M.P. (IN. HG.)	M.P. (IN. HG.)	M.P. (IN. HG.)	M.P. (IN. HG.)	M.P. (IN. HG.)	R.P.M.	I.A.S. M.P.H.
2300	156 A.R.	38 1/3	36 1/3	2100	160 A.L.	31 2/3	30 2/3	2060	149 A.L.
2300	172 A.R.	38 1/3	34 1/3	2100	167 A.L.	31 2/3	30 2/3	2050	157 A.L.
2300	183 A.R.	38 1/3	32 1/3	2100	173 A.L.	31 2/3	30 2/3	2050	164 A.L.
2300	192 A.R.	38 1/3	30 1/3	2100	178 A.L.	31 2/3	30 2/3	2050	170 A.L.
2300	197 A.R.	38 1/3	28 1/3	2100	182 A.L.	31 2/3	30 2/3	2050	175 A.L.
2300	202 A.R.	38 1/3	26 1/3	2100	185 A.L.	30.5 2/3	29.5 2/3	2050	179 A.L.
2300	207 A.R.	38 1/3	24 1/3	2100	179 A.L.	31.5 2/3	30 2/3	2050	170 A.L.
2300	210 A.R.	38 1/3	22 1/3	2100	183 A.L.	31.5 2/3	30 2/3	2050	175 A.L.
2300	214 A.R.	38 1/3	20 1/3	2100	187 A.L.	31 2/3	29.5 2/3	2050	179 A.L.
DENSITY ALT. (IN FEET)		DENSITY ALT. (IN FEET)		DENSITY ALT. (IN FEET)		DENSITY ALT. (IN FEET)		DENSITY ALT. (IN FEET)	
30000	30000	25000	25000	20000	20000	15000	15000	10000	10000
25000	25000	20000	20000	15000	15000	10000	10000	5000	5000
20000	20000	15000	15000	10000	10000	5000	5000	S.L.	S.L.

I.A.S.: Indicated Air Speed
M.P.: Manifold Pressure (in. Hg.)
G.P.H.: U.S. Gallons Per Hour
I.W.C.P.H.: Imperial Gallons Per Hour
P.T.: Full Thrust
S.L.: Sea Level

BOLD NUMBERS: Use Auto-Rick
LIGHT NUMBERS: Use Auto-Rick
WITH TWO SPEED BLOWER: Use high
blower above heavy line only

INDICATED ALTITUDE CORRECTED FOR FREE AIR TEMPERATURE
ALLOW 212 U.S. GALS. IMP. GALS. FOR WARM UP.
TAKE-OFF AND CLIMB TO 5,000 FEET ALTITUDE
RETURN FUEL FLOWS TO TANK
USE FUEL FROM TANKS IN THE FOLLOWING ORDER

REFER TO "SPECIFIC ENGINE FLIGHT CHART" FOR ADDITIONAL ENGINE OPERATION DATA.

RANGES SHOWN ARE 90% OF FLIGHT TEST VALUES.

Flight Operation Chart (no external load) 7 Sheets

MODEL (S) B-17F				FLIGHT OPERATION INSTRUCTION CHART SHEET 2 OF 7 SHEETS				EXTERNAL LOAD ITEMS NONE																									
FORM ASC-1114				GR. WT. 65,000 TO 60,000 POUNDS																													
CONDITION	R.P.M.	M.P.	BLOWER POSITION	MIXTURE POSITION	DURATION IN MIN.	U.S. G.P.H.	IMP. G.P.H.	INSTRUCTIONS FOR USING CHART: Select figure in fuel column equal to or less than total amount of fuel in airplanes. Move horizontally to the right or left and select a figure equal to or greater than the air miles to be flown. Vertically below and opposite desired cruising altitude read optimum cruising conditions. NOTES: (A) Avoid continuous cruising in Column I in the upper left corner of chart.																									
TAXI-OFF	2600	46	-	A.R.	5	608	-																										
MILITARY POWER	2600	46	-	A.R.	5	608	-																										
ENGINE (S)	R-1820-97																																
ALTERNATE CRUISING CONDITIONS (NO RESERVE FUEL ALLOWANCE)																																	
I (NO WIND)																																	
1 NORMAL RATED (MAX. CONT.)			II			III			IV																								
RANGE IN AIR MILES			RANGE IN AIR MILES			RANGE IN AIR MILES			RANGE IN AIR MILES																								
STATUTE	NAUTICAL	FUEL U.S. GALS.	STATUTE	NAUTICAL	FUEL U.S. GALS.	STATUTE	NAUTICAL	FUEL U.S. GALS.	STATUTE	NAUTICAL	FUEL U.S. GALS.																						
AT S.L.	AT S.L.	AT S.L.	CONTINUED FROM SHEET 1																														
900	780	1600	1170	1030	1600	1300	1130	1450	1260																								
780	690	1400	1020	890	1400	1140	990	1270	1100																								
680	590	1200	870	760	1200	970	650	1080	950																								
560	490	1000	730	630	1000	810	700	900	780																								
450	390	800	580	510	800	650	560	720	630																								
OPERATING DATA																																	
R.P.M.	I.A.S. M.P.H.	MIX-TURE IN. Hg	IMP. G. P. H.	U.S. G. P. H.	DENSITY ALT. IN FEET	R.P.M.	I.A.S. M.P.H.	MIX-TURE IN. Hg	IMP. G. P. H.	U.S. G. P. H.	DENSITY ALT. IN FEET																						
2300	156	A.R. 38	413	30000	30000	2150	161	A.R. 31.5	284	2100	160	A.L. 31	253	2050	157	A.L. 30	212	2050	164	A.L. 30	212	2050	170	A.L. 30	211	2050	175	A.L. 29.5	208	2050	179	A.L. 28.5	203
2300	172	A.R. 38	413	25000	25000	2150	168	A.R. 32	296	2100	187	A.L. 31	252	2050	157	A.L. 30	212	2050	164	A.L. 30	212	2050	170	A.L. 30	211	2050	175	A.L. 29.5	208	2050	179	A.L. 28.5	203
2300	183	A.R. 38	413	20000	20000	2150	175	A.R. 31.5	280	2100	173	A.L. 31	250	2050	157	A.L. 30	212	2050	164	A.L. 30	212	2050	170	A.L. 30	211	2050	175	A.L. 29.5	208	2050	179	A.L. 28.5	203
2300	192	A.R. 38	413	15000	15000	2150	186	A.R. 32	296	2100	180	A.L. 31	253	2050	157	A.L. 30	212	2050	164	A.L. 30	212	2050	170	A.L. 30	211	2050	175	A.L. 29.5	208	2050	179	A.L. 28.5	203
2300	197	A.R. 38	413	12000	12000	2150	172	A.R. 32	290	2100	187	A.L. 31	252	2050	157	A.L. 30	212	2050	164	A.L. 30	212	2050	170	A.L. 30	211	2050	175	A.L. 29.5	208	2050	179	A.L. 28.5	203
2300	202	A.R. 38	413	9000	9000	2150	175	A.R. 31.5	280	2100	173	A.L. 31	250	2050	157	A.L. 30	212	2050	164	A.L. 30	212	2050	170	A.L. 30	211	2050	175	A.L. 29.5	208	2050	179	A.L. 28.5	203
2300	207	A.R. 38	413	6000	6000	2100	178	A.L. 31.5	273	2100	178	A.L. 31	245	2050	157	A.L. 30	212	2050	164	A.L. 30	212	2050	170	A.L. 30	211	2050	175	A.L. 29.5	208	2050	179	A.L. 28.5	203
2300	210	A.R. 38	413	3000	3000	2100	183	A.L. 31.5	269	2090	182	A.L. 31	240	2050	157	A.L. 30	212	2050	164	A.L. 30	212	2050	170	A.L. 30	211	2050	175	A.L. 29.5	208	2050	179	A.L. 28.5	203
2300	214	A.R. 38	413	S.L.	S.L.	2100	187	A.L. 31	262	2080	185	A.L. 30.5	236	2050	157	A.L. 30	212	2050	164	A.L. 30	212	2050	170	A.L. 30	211	2050	175	A.L. 29.5	208	2050	179	A.L. 28.5	203

1 INDICATED ALTITUDE CORRECTED FOR FREE AIR TEMPERATURE.
 2 ALLOW - U.S. GALS. - IMP. GALS. FOR WARM UP.
 3 TAKEOFF AND CLIMB TO - FEET ALTITUDE
 4 RETURN FUEL FLOWS TO TANK.
 5 USE FUEL FROM TANKS IN THE FOLLOWING ORDER.
 6 REFER TO "SPECIFIC ENGINE FLIGHT CHART" FOR ADDITIONAL ENGINE OPERATION DATA.
 7 RANGES SHOWN ARE 90% OF FLIGHT TEST VALUES.
 8 W.P. 11-14-43-03

I.A.S.: Indicated Air Speed
 M.P.H.: Manifold Pressure (In. Hg)
 U.S.G.P.H.: U.S. Gallons Per Hour
 IMP.G.P.H.: Imperial Gallons Per Hour
 R.P.M.: Full Thrust
 S.L.: Sea Level

W.P. 11-14-43-03

Flight Operation Chart (no external load), 7 Sheets

MODEL(S) B-17F		FLIGHT OPERATION INSTRUCTION CHART		EXTERNAL LOAD ITEMS			
FORM ASC511A		SHEET 3 OF 7 SHEETS		NONE			
GR. WT. 60,000		TO 55,000 POUNDS					
CONDITION	E.P.M.	M.P. (IN. HG.)	BLOWER POSITION	MIXTURE POSITION	DURATION IN AIR	U.S. G.P.H.	IMP. G.P.H.
TAKE OFF	2500	46	-	A.R.	5	608	-
MILITARY POWER	2500	46	-	A.R.	5	608	-
ENGINE ID	R-1820-97						
(NO WIND)							
ALTERNATE CRUISING CONDITIONS							
(NO RESERVE FUEL ALLOWANCE)							
I NORMAL RATED (MAX. CONT.)		II		III		IV (MAX. RANGE)	
RANGE IN AIR MILES		RANGE IN AIR MILES		RANGE IN AIR MILES		RANGE IN AIR MILES	
STATUTE	NAUTICAL	STATUTE	NAUTICAL	STATUTE	NAUTICAL	STATUTE	NAUTICAL
AT S.L.	AT S.L.	AT S.L.	AT S.L.	AT S.L.	AT S.L.	AT S.L.	AT S.L.
1530	1830	1900	1650	2090	1820	2280	1980
1410	1730	1780	1530	1930	1680	2100	1830
1300	1630	1610	1400	1770	1540	1930	1680
1180	1430	1470	1280	1610	1400	1750	1520
1060	920	1320	1150	1450	1260	1580	1370
940	820	1170	1020	1280	1120	1400	1220
820	710	1030	900	1130	980	1230	1070
710	620	880	770	970	840	1050	910
590	510	730	640	810	700	880	780
470	410	590	510	640	560	700	610
CONTINUED ON SHEET 4							
OPERATING DATA		OPERATING DATA		OPERATING DATA		OPERATING DATA	
R.P.M.	I.A.S. MIX-TURE	M.P. (IN. HG.)	U.S. G.P.H.	IMP. G.P.H.	DENSITY ALT. (IN FEET)	R.P.M.	I.A.S. MIX-TURE
2300	164 A.R.	38	413	30000	30000	2100	143 A.L.
2300	175 A.R.	38	413	25000	25000	2100	157 A.L.
2300	186 A.R.	38	413	20000	20000	2100	165 A.L.
2300	194 A.R.	38	413	15000	15000	2100	169 A.L.
2300	199 A.R.	38	413	12000	12000	2100	173 A.L.
2300	203 A.R.	38	413	9000	9000	2100	177 A.L.
2300	209 A.R.	38	413	6000	6000	2050	181 A.L.
2300	213 A.R.	38	413	3000	3000	2050	184 A.L.
2300	217 A.R.	38	413	S.L.	S.L.	2000	177 A.L.
① INDICATED ALTITUDE CORRECTED FOR FREE AIR TEMPERATURE. ② ALLOW 70 U.S. GALS. - IMP. GALS. FOR WARM UP. TAKE-OFF AND CLIMB TO 3000 FEET ALTITUDE RETURN FUEL FLOWS TO TANK. USE FUEL FROM TANKS IN THE FOLLOWING ORDER: REFER TO "SPECIFIC ENGINE FLIGHT CHART" FOR ADDITIONAL ENGINE OPERATION DATA. RANGES SHOWN ARE 90% OF FLIGHT TEST VALUES.							

Flight Operation Chart (no external load) 7 Sheets

MODEL(S) B-17F		FLIGHT OPERATION INSTRUCTION CHART				EXTERNAL LOAD ITEMS			
FORM ASC-11A		SHEET 4 OF 7 SHEETS				NONE			
GR. WT.		60,000				POUNDS			
CONDITION	R.P.M.	M.P.	BLOWER POSITION	DURATION IN MIN.	U.S. G.P.H.	IMP. G.P.H.	INSTRUCTIONS FOR USING CHART: Select figure in fuel column equal to or less than total amount of fuel in airplane. Move horizontally to the right or left and select a figure equal to or greater than the air miles to be flown. Vertically below and opposite desired cruising altitude read optimum cruising conditions. NOTES: (A) Avoid continuous cruising in Column I in the upper left corner of chart.		
TAKE-OFF	2500	46	-	5	808	-			
MILITARY POWER	2500	46	-	5	808	-			
ENGINE ID	R-1820-97								
ALTERNATE CRUISING CONDITIONS (NO WIND)									
(NO RESERVE FUEL ALLOWANCE)									
I NORMAL RATED (MAX. CONT.)									
RANGE IN AIR MILES		II		III		IV		V (MAX. RANGE)	
STATUTE	NAUTICAL	STATUTE	NAUTICAL	STATUTE	NAUTICAL	STATUTE	NAUTICAL	STATUTE	NAUTICAL
470	350	590	440	640	560	700	610	760	660
AT S.L.	AT 20,000	AT 20,000	AT 20,000	CONTINUED FROM SHEET 3	510	480	460	800	600
					380	320	300	800	500
					250	180	160	400	300
					100	180	160	200	170
OPERATING DATA									
R.P.M.	I.A.S. M.P.H.	MIX-TURE	U.S. G.P.H.	IMP. G.P.H.	DENSITY ALT. IN FEET	R.P.M.	I.A.S. M.P.H.	MIX-TURE	U.S. G.P.H.
2300	164	A.R.	38	413	30000	2100	143	A.L.	31
2300	175	A.R.	38	413	25000	2100	157	A.L.	31
2300	186	A.R.	38	413	20000	2100	165	A.L.	30.5
2300	194	A.R.	38	413	15000	2100	167	A.R.	31
2300	199	A.R.	38	413	12000	2100	173	A.R.	31
2300	203	A.R.	38	413	9000	2100	176	A.L.	31
2300	209	A.R.	38	413	6000	2100	182	A.L.	31
2300	213	A.R.	38	413	3000	2100	186	A.L.	31
2300	217	A.R.	38	413	S.L.	2100	189	A.L.	30.5

Flight Operation Chart (no external load) 7 Sheets

L ① INDICATED ALTITUDE CORRECTED FOR FREE AIR TEMPERATURE.
E ② ALLOW 170 U.S. GALS. - IMP. GALS. FOR WARM UP.
E TAKE-OFF AND CLIMB TO 5000 FEET ALTITUDE.
E RETURN FUEL FLOWS TO TANK.
N USE FUEL FROM TANKS IN THE FOLLOWING ORDER:
 REFER TO "SPECIFIC ENGINE FLIGHT CHART" FOR ADDITIONAL ENGINE OPERATION DATA.
W 1-1-48-13
 RANGES SHOWN ARE 90% OF FLIGHT TEST VALUES.
 BOLD NUMBERS: Use Auto-Rick
 LIGHT NUMBERS: Use Auto-Less
 WITH TWO SPEED BLOWER; Use High
 Slower above heavy line only
 U.S.: Indicated Air Speed
 M.P.: Manifold Pressure (In. Hg)
 U.S.G.P.H.: U.S. Gallons Per Hour
 IMP.G.P.H.: Imperial Gallons Per Hour
 A.L.: Full Thrust
 S.L.: Sea Level

MODEL (S) B-17F										FLIGHT OPERATION INSTRUCTION CHART										EXTERNAL LOAD ITEMS NONE																																		
FORM ASC-811A										SHEET 5 OF 7 SHEETS										OR. WT. 55,000 TO 50,000 POUNDS																																		
CONDITION		R.P.M.	M.P. (IN. HG.)	POSITION	MIXTURE POSITION	DURATION IN MIN.	U.S. G.P.H.	IMP. G.P.H.	INSTRUCTIONS FOR USING CHART: Select figure in fuel column equal to or less than total amount of fuel in airplane. Move horizontally to the right or left and select a figure equal to or greater than the air miles to be flown. Vertically below and opposite desired cruising altitude read optimum cruising conditions. NOTES: (A) Avoid continuous cruising in Column I in the upper left corner of chart.																																													
TAKE-OFF	2500	46	-	A.R.	5	608	-	-																																														
MILITARY POWER	2500	46	-	A.R.	5	608	-	-																																														
ENGINE (S)	R-1820-97																																																					
1 NORMAL RATED (MAX. CONT.)										ALTERNATE CRUISING CONDITIONS										INO RESERVE FUEL ALLOWANCE																																		
RANGE IN AIR MILES					RANGE IN AIR MILES					RANGE IN AIR MILES					RANGE IN AIR MILES					Y (MAX. RANGE)																																		
STATUTE		NAUTICAL		STATUTE		NAUTICAL		STATUTE		NAUTICAL		STATUTE		NAUTICAL		STATUTE		NAUTICAL		STATUTE		NAUTICAL																																
160 U.S. GALLONS NOT AVAILABLE IN FLIGHT																																																						
AT 5 L.	1360	1240	1110	990	870	740	620	490	370	250	120	1800	1600	1400	1200	1000	800	600	400	200	2360	2200	2000	1800	1600	1400	1200	1000	800	600	400	200	2270	2070	1860	1650	1450	1240	1030	830	620	420	210	1970	1800	1620	1440	1260	1080	900	720	540	370	180

Flight Operation Chart (no external load) 7 Sheets

INDICATED ALTITUDE CORRECTED FOR FREE AIR TEMPERATURE.
 1 ALLOW 180 U.S. GALS. TAKE-OFF AND CLIMB TO 5000 FT. ALTITUDE.
 RETURN FUEL FLOWS TO TANK.
 USE FUEL FROM TANKS IN THE FOLLOWING ORDER:
 REFER TO "SPECIFIC ENGINE FLIGHT CHART" FOR ADDITIONAL ENGINE OPERATION DATA.

BOLD NUMBERS: Use Auto-Rick LIGHT NUMBERS: Use Auto-Leak WITH TWO SPEED BLOWER: Use high blower above heavy line only

RANGES SHOWN ARE 90% OF FLIGHT TEST VALUES.

U.S.: Indicated Air Speed
 M.P.: Manifold Pressure (in. Hg.)
 U.S.G.P.H.: U.S. Gallons Per Hour
 IMP.G.P.H.: Imperial Gallons Per Hour
 F.T.: Feet
 S.L.: Sea Level

MODEL(S) B-17F		FLIGHT OPERATION INSTRUCTION CHART				EXTERNAL LOAD ITEMS								
FORM ASC-511A		SHEET 6 OF 7 SHEETS				NONE								
GR. WT. 50,000		POUNDS				TO 45,000								
CONDITION	R.P.M.	M.P. (IN. HG.)	BLOWER POSITION	DURATION (IN. MIN.)	U.S. G.P.H.	IMP. G.P.H.	INSTRUCTIONS FOR USING CHART: Select figure in fuel column equal to or less than total amount of fuel in airplane. Move horizontally to the right or left and select a figure equal to or greater than the air miles to be flown. Vertically below and opposite desired cruising altitude read optimum cruising conditions. NOTES: (A) Avoid continuous cruising in Column I in the upper left corner of chart.							
TAKE-OFF POWER	2500	46	A.R.	5	608	-	except in emergency. (B) Columns (II, III, IV & V) toward the right progressively give increase in range at sacrifice in speed. (C) Manifold Pressure (M.P.). Gallons Per Hour (G.P.H.), are approximate maximum values for reference. (D) For quick reference, take-off and military power data are listed in the upper left corner of chart.							
MILITARY POWER	2500	46	A.R.	5	608	-								
ENGINE IS:	R-1820-97													
ALTERNATE CRUISING CONDITIONS														
(NO WIND)														
I NORMAL RATED (MAX. CONT.)														
RANGE IN AIR MILES		FUEL U.S. GALLONS		II RANGE IN AIR MILES		III RANGE IN AIR MILES		IV RANGE IN AIR MILES		V (MAX. RANGE)				
STATUTE	NAUTICAL	STATUTE	NAUTICAL	STATUTE	NAUTICAL	STATUTE	NAUTICAL	STATUTE	NAUTICAL	STATUTE	NAUTICAL			
AT S.L.	AT 30,000	AT S.L.	AT 30,000	132 U.S. GALLONS NOT AVAILABLE IN FLIGHT	1230'	1080'	1040'	1000'	960'	1770	1540			
1100	950	1250	1090	1420	1230'	1080'	1040'	1000'	960'	1550	1340			
1020	880	1100	950	1250	1080'	1040'	1000'	960'	920'	1330	1150			
890	770	840	810	1070	930	890	870	800	770	1110	960			
770	670	780	670	890	770	710	610	600	520	890	770			
640	550	630	550	710	610	530	460	400	340	660	570			
510	440	470	400	530	460	360	310	270	200	440	380			
380	330	310	270	360	310	180	160	130	170	220	190			
260	220	150	130	180	160									
130	110													
OPERATING DATA		OPERATING DATA		OPERATING DATA		OPERATING DATA		OPERATING DATA		OPERATING DATA				
R.P.M.	I.A.S. M.P.H.	MIX-TURE (IN. HG.)	U.S. G.P.H.	IMP. G.P.H.	R.P.M.	I.A.S. M.P.H.	MIX-TURE (IN. HG.)	U.S. G.P.H.	IMP. G.P.H.	R.P.M.	I.A.S. M.P.H.	MIX-TURE (IN. HG.)	U.S. G.P.H.	IMP. G.P.H.
2300	178 A.R.	38 413	30000	2150	158 A.R.	32 302	2100	151 A.L.	31 255	2050	144 A.L.	30 216	30000	20000
2300	185 A.R.	38 413	25000	2150	166 A.R.	32 290	2100	161 A.L.	31 247	2050	156 A.L.	30 214	25000	20000
2300	192 A.R.	38 413	20000	2150	173 A.R.	31.5 277	2100	170 A.L.	30.5 239	2050	162 A.L.	30 204	20000	15000
2300	203 A.R.	38 413	15000	2100	179 A.L.	31 264	2050	176 A.L.	30 229	2000	168 A.L.	29 195	15000	12000
2300	208 A.R.	38 413	12000	2100	184 A.L.	31 259	2050	179 A.L.	30 220	2000	170 A.L.	29 188	12000	9000
2300	211 A.R.	38 413	9000	2100	187 A.L.	31 250	2050	181 A.L.	30 213	2000	172 A.L.	29 181	9000	6000
2300	214 A.R.	38 413	6000	2100	190 A.L.	31 243	2050	183 A.L.	30 206	1900	175 A.L.	29 176	6000	3000
2300	220 A.R.	38 413	3000	2100	193 A.L.	30.5 236	2050	185 A.L.	29.5 199	1800	176 A.L.	29 168	3000	S.L.
2300	226 A.R.	38 413	S.L.	2100	195 A.L.	30.5 228	2000	188 A.L.	29 193	1850	178 A.L.	29 161	S.L.	

INDICATED ALTITUDE CORRECTED FOR FREE AIR TEMPERATURE.
 TAKE-OFF AND CLIMB TO 5000 FEET ALTITUDE
 RETURN FUEL FLOWS TO TANK.
 USE FUEL FROM TANKS IN THE FOLLOWING ORDER:
 REFER TO "SPECIFIC ENGINE FLIGHT CHART" FOR ADDITIONAL ENGINE OPERATION DATA.
 RANGES SHOWN ARE 90% OF FLIGHT TEST VALUES.
 W.P.-1-48-13M

Flight Operation Chart (no external load) 7 Sheets

MODEL (S) B-17F		FLIGHT OPERATION INSTRUCTION CHART		EXTERNAL LOAD ITEMS	
FORM ASC-511A		SHEET 7 OF 7 SHEETS		NONE	
GR. WT. 45,000		POUNDS TO 40,000			
CONDITION	F	M.P. (M.H.) POSITION	SLOWEST MIXTURE POSITION	DURATION IN MIN.	U.S. G.P.H. IMP. G.P.H.
TAKE-OFF	2500	46	-	5	808 -
MILITARY POWER	2500	46	-	5	808 -
ENGINE (S)	R-1820-87				
INSTRUCTIONS FOR USING CHART: Select figure in fuel column equal to or less than total amount of fuel in airplane. Move horizontally to the right or left and select a figure equal to or greater than the air miles to be flown. Vertically below and opposite desired cruising altitude read optimum cruising conditions. NOTES: (A) Avoid continuous cruising in Column I in the upper left corner of chart.					
ALTERNATE CRUISING CONDITIONS (NO RESERVE FUEL ALLOWANCE)					
1 NORMAL RATED (MAX. CONT.)		II		III	
RANGE IN AIR MILES		RANGE IN AIR MILES		RANGE IN AIR MILES	
STATUTE NAUTICAL		STATUTE NAUTICAL		STATUTE NAUTICAL	
AT S.L. AT 30,000 AT S.L. AT 30,000		AT S.L. AT 30,000 AT S.L. AT 30,000		AT S.L. AT 30,000 AT S.L. AT 30,000	
FUEL U.S. GALS. ①		FUEL U.S. GALS. ①		FUEL U.S. GALS. ①	
650 520 400 290 190		860 680 520 340 170		960 770 580 380 190	
570 450 350 230 110		590 450 300 150		840 670 500 330 170	
1000 800 600 400 200		1000 800 600 400 200		1080 850 650 420 210	
R.P.M. I.A.S. MIX-TURE M.P. IN. Hg. P. H.		R.P.M. I.A.S. MIX-TURE M.P. IN. Hg. P. H.		R.P.M. I.A.S. MIX-TURE M.P. IN. Hg. P. H.	
2300 179 A.R. 38 413		2100 159 A.L. 32 281		2100 155 A.L. 31 245	
2300 188 A.R. 38 413		2100 165 A.L. 31 267		2100 163 A.L. 30.5 235	
2300 198 A.R. 38 413		2100 173 A.L. 31 256		2050 170 A.L. 30 224	
2300 205 A.R. 38 413		2100 180 A.L. 31 245		2050 176 A.L. 30 214	
2300 209 A.R. 38 413		2100 183 A.L. 30.5 239		2050 178 A.L. 30 207	
2300 214 A.R. 38 413		2100 186 A.L. 30.5 231		2000 180 A.L. 29 198	
2300 217 A.R. 38 413		2050 189 A.L. 30 223		2000 182 A.L. 29 183	
2300 221 A.R. 38 413		2050 191 A.L. 30 216		2000 184 A.L. 29 186	
2300 226 A.R. 38 413		2050 193 A.L. 30 209		1950 186 A.L. 29 179	
DENSITY ALT. IN FEET ①		DENSITY ALT. IN FEET ①		DENSITY ALT. IN FEET ①	
30000 25000 20000 15000 12000 5300 6000 3000 S.L.		30000 25000 20000 15000 12000 5300 6000 3000 S.L.		30000 25000 20000 15000 12000 9000 6000 3000 S.L.	
RANGES IN AIR MILES		RANGES IN AIR MILES		RANGES IN AIR MILES	
STATUTE NAUTICAL		STATUTE NAUTICAL		STATUTE NAUTICAL	
1160 930 710 480 230		1080 850 650 420 210		1080 850 650 420 210	
1010 810 620 400 200		920 740 570 370 190		920 740 570 370 190	
OPERATING DATA		OPERATING DATA		OPERATING DATA	
R.P.M. I.A.S. MIX-TURE M.P. IN. Hg. P. H.		R.P.M. I.A.S. MIX-TURE M.P. IN. Hg. P. H.		R.P.M. I.A.S. MIX-TURE M.P. IN. Hg. P. H.	
2300 179 A.R. 38 413		2100 159 A.L. 32 281		2100 155 A.L. 31 245	
2300 188 A.R. 38 413		2100 165 A.L. 31 267		2100 163 A.L. 30.5 235	
2300 198 A.R. 38 413		2100 173 A.L. 31 256		2050 170 A.L. 30 224	
2300 205 A.R. 38 413		2100 180 A.L. 31 245		2050 176 A.L. 30 214	
2300 209 A.R. 38 413		2100 183 A.L. 30.5 239		2050 178 A.L. 30 207	
2300 214 A.R. 38 413		2100 186 A.L. 30.5 231		2000 180 A.L. 29 198	
2300 217 A.R. 38 413		2050 189 A.L. 30 223		2000 182 A.L. 29 183	
2300 221 A.R. 38 413		2050 191 A.L. 30 216		2000 184 A.L. 29 186	
2300 226 A.R. 38 413		2050 193 A.L. 30 209		1950 186 A.L. 29 179	
INDICATED ALTITUDE CORRECTED FOR FREE AIR TEMPERATURE		INDICATED ALTITUDE CORRECTED FOR FREE AIR TEMPERATURE		INDICATED ALTITUDE CORRECTED FOR FREE AIR TEMPERATURE	
ALLOW. U.S. GALS. - IMP. GALS. FOR WARM UP.		ALLOW. U.S. GALS. - IMP. GALS. FOR WARM UP.		ALLOW. U.S. GALS. - IMP. GALS. FOR WARM UP.	
TAKE-OFF AND CLIMB TO - FEET ALTITUDE		TAKE-OFF AND CLIMB TO - FEET ALTITUDE		TAKE-OFF AND CLIMB TO - FEET ALTITUDE	
RETURN FUEL FLOWS TO TANK		RETURN FUEL FLOWS TO TANK		RETURN FUEL FLOWS TO TANK	
USE FUEL FROM TANKS IN THE FOLLOWING ORDER		USE FUEL FROM TANKS IN THE FOLLOWING ORDER		USE FUEL FROM TANKS IN THE FOLLOWING ORDER	
REFER TO "SPECIFIC ENGINE FLIGHT CHART" FOR ADDITIONAL ENGINE OPERATION DATA.		REFER TO "SPECIFIC ENGINE FLIGHT CHART" FOR ADDITIONAL ENGINE OPERATION DATA.		REFER TO "SPECIFIC ENGINE FLIGHT CHART" FOR ADDITIONAL ENGINE OPERATION DATA.	

① INDICATED ALTITUDE CORRECTED FOR FREE AIR TEMPERATURE.
 ② ALLOW. U.S. GALS. - IMP. GALS. FOR WARM UP.
 TAKE-OFF AND CLIMB TO - FEET ALTITUDE
 RETURN FUEL FLOWS TO TANK
 USE FUEL FROM TANKS IN THE FOLLOWING ORDER
 REFER TO "SPECIFIC ENGINE FLIGHT CHART" FOR ADDITIONAL ENGINE OPERATION DATA.

LEGEND
 I.A.S.: Indicated Air Speed
 M.P.: Manifold Pressure (In. Hg.)
 U.S.G.P.H.: U.S. Gallons Per Hour
 IMP.G.P.H.: Imperial Gallons Per Hour
 F.T.: Feet
 S.L.: Sea Level

BOLD NUMBERS: Use Auto-Rick
LIGHT NUMBERS: Use Auto-Las
 WITH TWO SPEED BLOWER. Use high
 blower above heavy line only

RANGES SHOWN ARE 90% OF FLIGHT TEST VALUES.

Flight Operation Chart (no external load) 7 Sheets

MODEL(S) B-17F		FLIGHT OPERATION INSTRUCTION CHART		EXTERNAL LOAD ITEMS (2) 2000 LB. BOMBS	
FORM ASC-11A		SHEET 1 OF 3 SHEETS		POUNDS	
GR. WT. 65,000 TO 60,000		INSTRUCTIONS FOR USING CHART: Select figure in fuel column equal to or less than total amount of fuel in airplane. Move horizontally to the right or left and select a figure equal to or greater than the air miles to be flown. Vertically below and opposite desired existing altitude read optimum cruising conditions. NOTES: (A) Avoid continuous cruising in Column I in the upper left corner of chart.		except in emergency. (B) Columns III, IV & V toward the right progressively give increase in range at sacrifice in speed. (C) Manifold Pressure (M.P.), Gallons Per Hour (G.P.H.), are approximate maximum values for reference. (D) For quick reference, take-off and military power data are listed in the upper left corner of chart.	
ENGINE (S)		MIXTURE POSITION		U.S. G.P.H.	
R-1820-97		A. R.		608	
MILITARY POWER		A. R.		608	
TAKE-OFF		5		608	
MILITARY POWER		5		608	
DURATION IN MIN.		5		608	
M.P. POSITION		A. R.		608	
M.P. POSITION		A. R.		608	
ALTERNATE CRUISING CONDITIONS					
INO WINDS					
I NORMAL RATED (MAX. CONT.)					
RANGE IN AIR MILES		FUEL U.S. GALLS.		V (MAX. RANGE)	
STATUTE NAUTICAL		STATUTE NAUTICAL		STATUTE NAUTICAL	
AT S.L. AT 25,000 AT S.L. AT 25,000	AT S.L. AT 25,000 AT S.L. AT 25,000	AT S.L. AT 25,000 AT S.L. AT 25,000	AT S.L. AT 25,000 AT S.L. AT 25,000	AT S.L. AT 25,000 AT S.L. AT 25,000	AT S.L. AT 25,000 AT S.L. AT 25,000
1110 970	1110 970	2282 2100	2282 2100	1720 1490	1720 1490
1050 910	1050 910	2000 1800	2000 1800	1630 1430	1630 1430
950 840	950 840	1800 1600	1800 1600	1470 1280	1470 1280
740 640	740 640	1400 1200	1400 1200	1310 1140	1310 1140
630 530	630 530	1200 1000	1200 1000	1160 1000	1160 1000
420 370	420 370	800 600	800 600	850 710	850 710
320 210	320 210	400 300	400 300	490 330	490 330
100 90	100 90	150 100	150 100	180 140	180 140
II					
RANGE IN AIR MILES		FUEL U.S. GALLS.		V (MAX. RANGE)	
STATUTE NAUTICAL		STATUTE NAUTICAL		STATUTE NAUTICAL	
182 U.S. GALLONS NOT AVAILABLE IN FLIGHT	182 U.S. GALLONS NOT AVAILABLE IN FLIGHT	2282 2100	2282 2100	1720 1490	1720 1490
1280 1080	1280 1080	2000 1800	2000 1800	1630 1430	1630 1430
1340 1160	1340 1160	1800 1600	1800 1600	1470 1280	1470 1280
1050 940	1050 940	1400 1200	1400 1200	1310 1140	1310 1140
840 730	840 730	1200 1000	1200 1000	1160 1000	1160 1000
720 600	720 600	800 600	800 600	850 710	850 710
480 480	480 480	400 300	400 300	490 330	490 330
360 240	360 240	150 100	150 100	180 140	180 140
120 100	120 100				
III					
RANGE IN AIR MILES		FUEL U.S. GALLS.		V (MAX. RANGE)	
STATUTE NAUTICAL		STATUTE NAUTICAL		STATUTE NAUTICAL	
900 780	900 780	2282 2100	2282 2100	1720 1490	1720 1490
750 650	750 650	2000 1800	2000 1800	1630 1430	1630 1430
600 520	600 520	1800 1600	1800 1600	1470 1280	1470 1280
450 380	450 380	1400 1200	1400 1200	1310 1140	1310 1140
300 260	300 260	1200 1000	1200 1000	1160 1000	1160 1000
150 110	150 110	800 600	800 600	850 710	850 710
		400 300	400 300	490 330	490 330
		150 100	150 100	180 140	180 140
IV					
RANGE IN AIR MILES		FUEL U.S. GALLS.		V (MAX. RANGE)	
STATUTE NAUTICAL		STATUTE NAUTICAL		STATUTE NAUTICAL	
900 780	900 780	2282 2100	2282 2100	1720 1490	1720 1490
750 650	750 650	2000 1800	2000 1800	1630 1430	1630 1430
600 520	600 520	1800 1600	1800 1600	1470 1280	1470 1280
450 380	450 380	1400 1200	1400 1200	1310 1140	1310 1140
300 260	300 260	1200 1000	1200 1000	1160 1000	1160 1000
150 110	150 110	800 600	800 600	850 710	850 710
		400 300	400 300	490 330	490 330
		150 100	150 100	180 140	180 140
OPERATING DATA					
R.P.M.		M.P.		DENSITY	
I.A.S. M.P.H.		I.A.S. M.P.H.		I.A.S. M.P.H.	
2300 158	2300 158	30000 25000	30000 25000	0.0011 0.0011	0.0011 0.0011
2300 172	2300 172	20000 15000	20000 15000	0.0011 0.0011	0.0011 0.0011
2300 179	2300 179	12000 9000	12000 9000	0.0011 0.0011	0.0011 0.0011
2300 183	2300 183	6000 3000	6000 3000	0.0011 0.0011	0.0011 0.0011
2300 188	2300 188	S.L.	S.L.	0.0011 0.0011	0.0011 0.0011
2300 192	2300 192			0.0011 0.0011	0.0011 0.0011
2300 199	2300 199			0.0011 0.0011	0.0011 0.0011
2300 203	2300 203			0.0011 0.0011	0.0011 0.0011
OPERATING DATA					
R.P.M.		M.P.		DENSITY	
I.A.S. M.P.H.		I.A.S. M.P.H.		I.A.S. M.P.H.	
2050 142	2050 142	30000 25000	30000 25000	0.0011 0.0011	0.0011 0.0011
2050 147	2050 147	20000 15000	20000 15000	0.0011 0.0011	0.0011 0.0011
2050 154	2050 154	12000 9000	12000 9000	0.0011 0.0011	0.0011 0.0011
2050 160	2050 160	6000 3000	6000 3000	0.0011 0.0011	0.0011 0.0011
2050 164	2050 164	S.L.	S.L.	0.0011 0.0011	0.0011 0.0011
2050 168	2050 168			0.0011 0.0011	0.0011 0.0011

INDICATED ALTITUDE CORRECTED FOR FREE AIR TEMPERATURE
ALLOW 182 U.S. GALLONS PER HOUR FOR WARM UP.
TAKE-OFF AND CLIMB TO 5000 FEET ALTITUDE
RETURN FUEL FLOWS TO TANK.
USE FUEL FROM TANKS IN THE FOLLOWING ORDER
REFER TO "SPECIFIC ENGINE FLIGHT CHART" FOR ADDITIONAL ENGINE OPERATION DATA.

LEGEND
I.A.S. - Indicated Air Speed
M.P. - Manifold Pressure (In. Hg)
U.S.G.P.H. - U.S. Gallons Per Hour
R.P.M. - Revolutions Per Minute
F.T. - Full Throttle
S.L. - Sea Level

BOLD NUMBERS: Use Auto-Rick
LIGHT NUMBERS: Use Auto-Lean
WITH TWO SPEED GEAR. Use High
Slower above heavy line only

RANGES SHOWN ARE 90% OF FLIGHT TEST VALUES.

Flight Operation Chart (external load - two 2000-pound bombs) 3 Sheets

MODEL(S) B-17F	FLIGHT OPERATION INSTRUCTION CHART	EXTERNAL LOAD ITEMS (2) 2000 LB. BOMBS															
SHEET 2 OF 3 SHEETS	GR. WT. 60,000	POUNDS 55,000															
<p>INSTRUCTIONS FOR USING CHART: Select figure in fuel column equal to or less than total amount of fuel in airplanes. Move horizontally to the right or left and select a figure equal to or greater than the air miles to be flown. Vertically below and opposite desired cruising altitude read optimum cruising conditions. NOTES: (A) Avoid continuous cruising in Column I in the upper-left corner of chart.</p>																	
ALTERNATE CRUISING CONDITIONS			NO RESERVE FUEL ALLOWANCE														
I NORMAL RATED (MAX. CONT.)			II			III			IV			V (MAX. RANGE)					
FUEL U.S. GALS. (1)			FUEL U.S. GALS. (1)			FUEL U.S. GALS. (1)			FUEL U.S. GALS. (1)			FUEL U.S. GALS. (1)					
RANGE IN AIR MILES STATUTE NAUTICAL			RANGE IN AIR MILES STATUTE NAUTICAL			RANGE IN AIR MILES STATUTE NAUTICAL			RANGE IN AIR MILES STATUTE NAUTICAL			RANGE IN AIR MILES STATUTE NAUTICAL					
AT 5,000 FT. ALT. 10,000 FT. ALT. 15,000 FT. ALT.			AT 5,000 FT. ALT. 10,000 FT. ALT. 15,000 FT. ALT.			AT 5,000 FT. ALT. 10,000 FT. ALT. 15,000 FT. ALT.			AT 5,000 FT. ALT. 10,000 FT. ALT. 15,000 FT. ALT.			AT 5,000 FT. ALT. 10,000 FT. ALT. 15,000 FT. ALT.					
R.P.M.	M.P.H.	U.S. G.P.H.	R.P.M.	M.P.H.	U.S. G.P.H.	R.P.M.	M.P.H.	U.S. G.P.H.	R.P.M.	M.P.H.	U.S. G.P.H.	R.P.M.	M.P.H.	U.S. G.P.H.	R.P.M.	M.P.H.	U.S. G.P.H.
2600	146	5	2200	146	3	2100	148	3	2050	149	3	2050	154	3	2050	159	3
2500	146	5	2150	157	3	2100	162	3	2050	162	3	2050	167	3	2050	170	3
			2100	163	3	2100	168	3	2100	174	3	2100	174	3	2100	174	3
			2100	171	3	2100	177	3	2100	180	3	2100	180	3	2100	180	3
			2100	183	3	2100	183	3	2100	183	3	2100	183	3	2100	183	3
			2100	188	3	2100	188	3	2100	188	3	2100	188	3	2100	188	3
			2100	193	3	2100	193	3	2100	193	3	2100	193	3	2100	193	3
			2100	198	3	2100	198	3	2100	198	3	2100	198	3	2100	198	3
			2100	201	3	2100	201	3	2100	201	3	2100	201	3	2100	201	3
			2100	205	3	2100	205	3	2100	205	3	2100	205	3	2100	205	3
			S.L.			S.L.			S.L.			S.L.			S.L.		

Flight Operation Chart (external load - two 2000- pound bombs) 3 Sheets

(1) INDICATED ALTITUDE CORRECTED FOR FREE AIR TEMPERATURE
 (2) ALLOW 150 U.S. GALS. IMP. GALS. FOR WARM UP
 TAKE-OFF AND CLIMB TO 5,000 FEET ALTITUDE
 RETURN FUEL FLOWS TO TANK
 USE FUEL FROM TANKS IN THE FOLLOWING ORDER:
 REFER TO "SPECIFIC ENGINE FLIGHT CHART" FOR ADDITIONAL ENGINE OPERATION DATA

NOTE: Indicated Air Speed
 M.P.H.: Manifold Pressure (In. Hg.)
 U.S.G.P.H.: U.S. Gallons Per Hour
 IMP.G.P.H.: Imperial Gallons Per Hour
 FT.: Feet Thrust
 S.L.: Sea Level

BOLD NUMBERS: Use Auto-Rick
 LIGHT NUMBERS: Use Auto-Lean
 WITH TWO SPEED BLOWER: Use High
 lower above heavy line only

RANGES SHOWN ARE 90% OF FLIGHT TEST VALUES.

MODEL (S) B-17F		FLIGHT OPERATION INSTRUCTION CHART		EXTERNAL LOAD ITEMS (2) 2000 LB. BOMBS			
FORM ASC 511A		SHEET 3 OF 3 SHEETS		POUNDS			
GR. WT. 55,000		TO 50,000					
CONDITION	R.P.M.	M.P. (IN. HG.)	SLOWER POSITION	MIXTURE POSITION	DURATION IN MIN.	U.S. G.P.H.	IMP. G.P.H.
TAKE-OFF	2500	46	-	A.R.	5	608	-
MILITARY POWER	2500	46	-	A.R.	5	608	-
ENGINE IS	R-1820-97						
INSTRUCTIONS FOR USING CHART: Select figure in fuel column equal to or less than total amount of fuel in airplane. Move horizontally to the right or left and select a figure equal to or greater than the air miles to be flown. Vertically below and opposite desired cruising altitude read optimum cruising conditions. NOTES: (A) Avoid continuous cruising in Column I in the upper left corner of chart.							
ALTERNATE CRUISING CONDITIONS				INO RESERVE FUEL ALLOWANCE			
I NORMAL RATED (MAX. CONT.)		II		III		IV	
RANGE IN AIR MILES		RANGE IN AIR MILES		RANGE IN AIR MILES		RANGE IN AIR MILES	
STATUTE NAUTICAL		STATUTE NAUTICAL		STATUTE NAUTICAL		STATUTE NAUTICAL	
AT S.L. AT 30,000 AT S.L. AT 30,000		AT S.L. AT 30,000 AT S.L. AT 30,000		AT S.L. AT 30,000 AT S.L. AT 30,000		AT S.L. AT 30,000 AT S.L. AT 30,000	
360 230 120		410 270 130		470 300 150		530 340 170	
320 200 100		360 230 110		410 260 130		460 300 150	
620 400 200		620 400 200		620 400 200		620 400 200	
FUEL U.S. GALLS.		FUEL U.S. GALLS.		FUEL U.S. GALLS.		FUEL U.S. GALLS.	
STATUTE NAUTICAL		STATUTE NAUTICAL		STATUTE NAUTICAL		STATUTE NAUTICAL	
590 380 190		590 380 190		590 380 190		590 380 190	
510 330 170		510 330 170		510 330 170		510 330 170	
Y (MAX. RANGE)		Y (MAX. RANGE)		Y (MAX. RANGE)		Y (MAX. RANGE)	
STATUTE NAUTICAL		STATUTE NAUTICAL		STATUTE NAUTICAL		STATUTE NAUTICAL	
590 380 190		590 380 190		590 380 190		590 380 190	
510 330 170		510 330 170		510 330 170		510 330 170	
OPERATING DATA		OPERATING DATA		OPERATING DATA		OPERATING DATA	
R.P.M.	I.A.S. M.P.H.	MIX. TUBE IN. HG.	U.S. G.P.H.	IMP. G.P.H.	DENSITY ALT. IN FEET	R.P.M.	I.A.S. M.P.H.
2300 2300 2300 2300 2300 2300 2300 2300 2300 2300	158 170 180 188 191 195 188 191 208 210	A.R. A.R. A.R. A.R. A.R. A.R. A.R. A.R. A.R. A.R.	38 38 38 38 38 38 38 38 38 38	38 413 413 413 413 413 413 413 413 413	30000 25000 20000 15000 12000 9000 6000 3000 S.L.	2050 2100 2150 2100 2100 2100 2100 2100 2000 2000	137 147 157 159 163 168 169 172 168 169
OPERATING DATA		OPERATING DATA		OPERATING DATA		OPERATING DATA	
R.P.M.	I.A.S. M.P.H.	MIX. TUBE IN. HG.	U.S. G.P.H.	IMP. G.P.H.	DENSITY ALT. IN FEET	R.P.M.	I.A.S. M.P.H.
2300 2300 2300 2300 2300 2300 2300 2300 2300 2300	158 170 180 188 191 195 188 191 208 210	A.R. A.R. A.R. A.R. A.R. A.R. A.R. A.R. A.R. A.R.	38 38 38 38 38 38 38 38 38 38	38 413 413 413 413 413 413 413 413 413	30000 25000 20000 15000 12000 9000 6000 3000 S.L.	2050 2100 2150 2100 2100 2100 2100 2100 2000 2000	137 147 157 159 163 168 169 172 168 169

I.A.S.: Indicated Air Speed
 M.P.H.: Manifold Pressure (in. Hg)
 U.S.G.P.H.: U.S. Gallons Per Hour
 IMP.G.P.H.: Imperial Gallons Per Hour
 P.P.H.: Fuel Thrust
 S.L.: Sea Level

BOLD NUMBERS: Use Auto-Ries
 LIGHT NUMBERS: Use Auto-Less
 WITH TWO SPEED BLOWER: Use High Blower above heavy line only

INDICATED ALTITUDE CORRECTED FOR FREE AIR TEMPERATURE:
 1 ALLOW — U.S. GALS. — IMP. GALS. FOR WARM UP
 2 TAKE-OFF AND CLIMB TO — FEET ALTITUDE
 3 RETURN FUEL FLOWS TO TANK
 4 USE FUEL FROM TANKS IN THE FOLLOWING ORDER

REFER TO "SPECIFIC ENGINE FLIGHT CHART" FOR ADDITIONAL ENGINE OPERATION DATA.
 RANGES SHOWN ARE 90% OF FLIGHT TEST VALUES.

Flight Operation Chart (external load - two 2000- pound bombs) 3 Sheets

MODEL(S) B-17F		FLIGHT OPERATION INSTRUCTION CHART				EXTERNAL LOAD ITEMS (2) 4000 LB. BOMBS	
FORM ASC-511A		SHEET 1 OF 2 SHEETS				POUNDS	
GR. WT. 65,000 TO 60,000		INSTRUCTIONS FOR USING CHART: Select figure in fuel column equal to or less than total amount of fuel in airplane. Move horizontally to the right or left and select a figure equal to or greater than the air miles to be flown. Vertically below and opposite desired cruising altitude read optimum cruising conditions. NOTES: (A) Avoid continuous cruising in Column I in the upper left corner of chart.					
ENGINE USE		M.P. (IN. HO.)		DURATION IN MIN.		U.S. G.P.H.	
TAKE-OFF	2500	46	-	5	608	-	-
MILITARY POWER	2500	46	-	5	608	-	-
ENGINE USE		R-1820-97					
ALTERNATE CRUISING CONDITIONS							
(NO WIND)							
I NORMAL RATED (MAX. CONT.)							
RANGE IN AIR MILES		FUEL U.S. GALS.		III RANGE IN AIR MILES		IV RANGE IN AIR MILES	
STATUTE NAUTICAL		STATUTE NAUTICAL		STATUTE NAUTICAL		STATUTE NAUTICAL	
132 U.S. GALLONS NOT AVAILABLE IN FLIGHT							
AT S.L. AT 25,000	790	1400	1732	1040	900	1170	1020
	690	1400	1600	910	790	1030	900
	590	1200	1400	780	680	880	770
	490	1000	1000	650	570	730	640
	400	800	800	520	450	590	510
	300	600	600	380	340	440	380
	200	400	400	260	230	300	260
OPERATING DATA		OPERATING DATA		OPERATING DATA		OPERATING DATA	
R.P.M.	I.A.S. MIX-TURE	R.P.M.	I.A.S. MIX-TURE	R.P.M.	I.A.S. MIX-TURE	R.P.M.	I.A.S. MIX-TURE
2300	150 A.R. 38	2150	149 A.R. 32	2100	145 A.L. 31	2100	141 A.L. 31
2300	162 A.R. 38	2150	164 A.R. 32	2100	161 A.L. 30.5	2100	158 A.L. 30.5
2300	171 A.R. 38	2150	157 A.R. 31.5	2100	156 A.L. 31	2100	154 A.L. 30.5
2300	175 A.R. 38	2150	160 A.R. 31.5	2100	161 A.L. 30.5	2100	158 A.L. 30.5
2300	179 A.R. 38	2150	168 A.R. 31	2100	166 A.L. 30.5	2100	164 A.L. 30.5
2300	183 A.R. 38	2150	164 A.R. 31	2100	166 A.L. 30.5	2100	164 A.L. 30.5
2300	189 A.R. 38	2150	168 A.R. 31	2100	166 A.L. 30.5	2100	164 A.L. 30.5
2300	194 A.R. 38	2150	168 A.R. 31	2100	166 A.L. 30.5	2100	164 A.L. 30.5
OPERATING DATA		OPERATING DATA		OPERATING DATA		OPERATING DATA	
R.P.M.	I.A.S. MIX-TURE	R.P.M.	I.A.S. MIX-TURE	R.P.M.	I.A.S. MIX-TURE	R.P.M.	I.A.S. MIX-TURE
30000	20000	30000	20000	30000	20000	30000	20000
25000	20000	25000	20000	25000	20000	25000	20000
20000	15000	20000	15000	20000	15000	20000	15000
15000	12000	15000	12000	15000	12000	15000	12000
12000	9000	12000	9000	12000	9000	12000	9000
9000	6000	9000	6000	9000	6000	9000	6000
6000	3000	6000	3000	6000	3000	6000	3000
3000	S.L.	3000	S.L.	3000	S.L.	3000	S.L.
S.L.		S.L.		S.L.		S.L.	

Flight Operation Chart (external load - two 4000- pound bombs) 2 Sheets

I.A.S.: Indicated Air Speed
M.P.: Manifold Pressure (In. Hg)
U.S.G.P.H.: U.S. Gallons Per Hour
IMP.G.P.H.: Imperial Gallons Per Hour
P.T.: Full Thrust
S.L.: Sea Level

INDICATED ALTITUDE CORRECTED FOR FREE AIR TEMPERATURE.
ALLOW 132 U.S. GALS. TAKE-OFF AND CLIMB TO 5000 FEET ALTITUDE.
RETURN FUEL FLOWS TO TANK.
USE FUEL FROM TANKS IN THE FOLLOWING ORDER:
1. INDICATED ALTITUDE CORRECTED FOR FREE AIR TEMPERATURE.
2. ALLOW 132 U.S. GALS. TAKE-OFF AND CLIMB TO 5000 FEET ALTITUDE.
3. RETURN FUEL FLOWS TO TANK.

NOTE: INDICATED ALTITUDE CORRECTED FOR FREE AIR TEMPERATURE.
ALLOW 132 U.S. GALS. TAKE-OFF AND CLIMB TO 5000 FEET ALTITUDE.
RETURN FUEL FLOWS TO TANK.
USE FUEL FROM TANKS IN THE FOLLOWING ORDER:

RANGES SHOWN ARE 90% OF FLIGHT TEST VALUES.

MODEL(S) B-17F				FLIGHT OPERATION INSTRUCTION CHART				EXTERNAL LOAD ITEMS (2) 4000 LB. BOMBS																
FORM ASC-11A		SHEET 2 OF 2 SHEETS		GR. WT. 60000		POUNDS																		
INSTRUCTIONS FOR USING CHART: Select figure in fuel column equal to or less than total amount of fuel in airplane. Move horizontally to the right or left and select a figure equal to or greater than the air miles to be flown. Vertically below and opposite desired cruising altitude read optimum cruising conditions. NOTES: (A) Avoid continuous cruising in Column I in the upper left corner of chart.				except in emergency. (B) Columns (II, III, IV & V) toward the right progressively give increase in range at sacrifice in speed. (C) Manifold Pressure (M.P.), Gallons Per Hour (G.P.H.), are approximate maximum values for reference. (D) For quick reference, take-off and military power data are listed in the upper left corner of chart.																				
ENGINE USE R-1820-97				(NO WIND)				NO RESERVE FUEL ALLOWANCE																
T NORMAL RATED (MAX. CONT.)				II				III				IV				V (MAX. RANGE)								
RANGE IN AIR MILES		RANGE IN AIR MILES		RANGE IN AIR MILES		RANGE IN AIR MILES		RANGE IN AIR MILES		RANGE IN AIR MILES		RANGE IN AIR MILES		RANGE IN AIR MILES		RANGE IN AIR MILES		RANGE IN AIR MILES		RANGE IN AIR MILES				
STATUTE		NAUTICAL		STATUTE		NAUTICAL		STATUTE		NAUTICAL		STATUTE		NAUTICAL		STATUTE		NAUTICAL		STATUTE				
AT S.L. AT 25,000		AT S.L. AT 25,000		AT S.L. AT 25,000		AT S.L. AT 25,000		AT S.L. AT 25,000		AT S.L. AT 25,000		AT S.L. AT 25,000		AT S.L. AT 25,000		AT S.L. AT 25,000		AT S.L. AT 25,000		AT S.L. AT 25,000				
410		360		470		410		530		460		590		510		660		560		660				
310		270		350		300		400		350		440		380		490		430		490				
210		180		240		210		270		230		300		260		320		280		320				
100		90		120		100		130		110		150		130		180		140		140				
FUEL U.S. GALS. ①		FUEL U.S. GALS. ①		FUEL U.S. GALS. ①		FUEL U.S. GALS. ①		FUEL U.S. GALS. ①		FUEL U.S. GALS. ①		FUEL U.S. GALS. ①		FUEL U.S. GALS. ①		FUEL U.S. GALS. ①		FUEL U.S. GALS. ①		FUEL U.S. GALS. ①				
800		800		800		800		800		800		800		800		800		800		800				
600		600		600		600		600		600		600		600		600		600		600				
400		400		400		400		400		400		400		400		400		400		400				
200		200		200		200		200		200		200		200		200		200		200				
OPERATING DATA		OPERATING DATA		OPERATING DATA		OPERATING DATA		OPERATING DATA		OPERATING DATA		OPERATING DATA		OPERATING DATA		OPERATING DATA		OPERATING DATA		OPERATING DATA				
R.P.M.	I.A.S. M.P.H.	MIX-TURE (IN. HG)	M.P. (IN. HG)	R.P.M.	I.A.S. M.P.H.	MIX-TURE (IN. HG)	M.P. (IN. HG)	R.P.M.	I.A.S. M.P.H.	MIX-TURE (IN. HG)	M.P. (IN. HG)	R.P.M.	I.A.S. M.P.H.	MIX-TURE (IN. HG)	M.P. (IN. HG)	R.P.M.	I.A.S. M.P.H.	MIX-TURE (IN. HG)	M.P. (IN. HG)	R.P.M.	I.A.S. M.P.H.	MIX-TURE (IN. HG)	M.P. (IN. HG)	
2300	166	A.R.	38	413	2200	140	A.R.	33	320	2100	148	A.L.	31	259	2050	144	A.L.	30.5	224	15000	145	N.P.	29	INCHES
2300	166	A.R.	38	413	2200	148	A.R.	33	316	2100	153	A.L.	31	256	2050	148	A.L.	30	220	12000	145	N.P.	29	INCHES
2300	176	A.R.	38	413	2150	156	A.R.	32.5	306	2100	158	A.L.	31	251	2050	152	A.L.	30	218	9000	145	N.P.	29	INCHES
2300	179	A.R.	38	413	2150	160	A.R.	32	300	2100	162	A.L.	31	248	2050	156	A.L.	30	213	6000	145	N.P.	29	INCHES
2300	184	A.R.	38	413	2150	163	A.R.	32	293	2100	166	A.L.	31	242	2050	160	A.L.	30	210	3000	145	N.P.	29	INCHES
2300	187	A.R.	38	413	2150	166	A.R.	31.5	285	2100	170	A.L.	31	237	2050	164	A.L.	30	206	S.L.	145	N.P.	29	INCHES
2300	192	A.R.	38	413	2100	169	A.L.	31.5	277	2100	172	A.L.	31	270	2050	164	A.L.	30	206	3000	145	N.P.	29	INCHES
2300	196	A.R.	38	413	2100	172	A.L.	31	270	2100	172	A.L.	31	270	2050	164	A.L.	30	206	S.L.	145	N.P.	29	INCHES

① INDICATED ALTITUDE CORRECTED FOR FREE AIR TEMPERATURE.
 ② ALLOW — U.S. GALS. — IMP. GALS. FOR WARM UP.
 TAKE-OFF AND CLIMB TO — FEET ALTITUDE
 RETURN FUEL FLOWS TO TANK.
 USE FUEL FROM TANKS IN THE FOLLOWING ORDER:
 REF. TO "SPECIFIC ENGINE RIGHT CHART" FOR ADDITIONAL ENGINE OPERATION DATA.

NOTE: INDICATED AIR SPEED
 M.P.: Manifold Pressure (In. Hg)
 U.S.G.P.H.: U.S. Gallons Per Hour
 IMP.G.P.H.: Imperial Gallons Per Hour
 P.L.: Fuel Thrust
 S.L.: Sea Level

HOLD NUMBERS: Use Auto-Blec
 LIGHT NUMBERS: Use Auto-Lecn
 WITH TWO SPEED BLOWER: Use High
 Blower above heavy line only.

Flight Operation Chart (external load - two 4000 - pound bombs) 2 Sheets

W.F. 13-0-0-0-0

RANGES SHOWN ARE 90% OF FLIGHT TEST VALUES.

MODEL(S) B-17F		3 ENGINE OPERATION		FLIGHT OPERATION INSTRUCTION CHART		EXTERNAL LOAD ITEMS 1 FEATHERED PROPELLER	
FORM ASC 311A		SHEET 1 OF 4 SHEETS		GR. WT. 60,000 TO 55,000 POUNDS			
CONDITION	R.P.M.	M.P. (IN. HG.)	MIXTURE POSITION	DURATION IN MIN.	U.S. G.P.H.	IMP. G.P.H.	
TAKE-OFF	2500	46	A.R.	5	458	-	
MILITARY POWER	2600	48	A.R.	5	458	-	
ENGINE ID	R-1820-97						
INSTRUCTIONS FOR USING CHART: Select figure in fuel column equal to or less than total amount of fuel in airplane. Move horizontally to the right or left and select a figure equal to or greater than the air miles to be flown. Vertically below and opposite desired cruising altitude read optimum cruising conditions. NOTES: (A) Avoid continuous cruising in Column I in the upper left corner of chart.							
ALTERNATE CRUISING CONDITIONS				NO RESERVE FUEL ALLOWANCE			
I NORMAL RATED (MAX. CONT.)		II		III		IV	
RANGE IN AIR MILES		RANGE IN AIR MILES		RANGE IN AIR MILES		RANGE IN AIR MILES	
STATUTE NAUTICAL		STATUTE NAUTICAL		STATUTE NAUTICAL		STATUTE NAUTICAL	
AT 51. AT 15,000 AT 31. AT 15,000		170 U.S. GALLONS NOT AVAILABLE IN FLIGHT.		170 U.S. GALLONS NOT AVAILABLE IN FLIGHT.		170 U.S. GALLONS NOT AVAILABLE IN FLIGHT.	
FUEL U.S. GALS.		FUEL U.S. GALS.		FUEL U.S. GALS.		FUEL U.S. GALS.	
2770 2600		2770 2600		2770 2600		2770 2600	
2400 2200 2000		2400 2200 2000		2400 2200 2000		2400 2200 2000	
1800 1600 1400		1800 1600 1400		1800 1600 1400		1800 1600 1400	
1200 1000 800		1200 1000 800		1200 1000 800		1200 1000 800	
DENSITY ALT. IN FEET		DENSITY ALT. IN FEET		DENSITY ALT. IN FEET		DENSITY ALT. IN FEET	
30000 25000 20000		30000 25000 20000		30000 25000 20000		30000 25000 20000	
15000 12000 9000		15000 12000 9000		15000 12000 9000		15000 12000 9000	
6000 3000 S.L.		6000 3000 S.L.		6000 3000 S.L.		6000 3000 S.L.	
OPERATING DATA		OPERATING DATA		OPERATING DATA		OPERATING DATA	
R.P.M.	I.A.S. M.P.H.	MIX-TURE IN. HG.	M.P. G. P. H.	R.P.M.	I.A.S. M.P.H.	MIX-TURE IN. HG.	M.P. G. P. H.
2300 2300 2300 2300 2300	159 A.R. 165 A.R. 171 A.R. 176 A.R. 181 A.R. 185 A.R.	38 310 38 310 38 310 38 310 38 310	310 320 327 325 322 311	2150 2150 2150	152 A.R. 157 A.R. 152 A.R.	32.5 32 31.5	230 227 211

I.A.S.: Indicated Air Speed
M.P.: Manifold Pressure (in. Hg)
U.S.G.P.H.: U.S. Gallons Per Hour
IMP.G.P.H.: Imperial Gallons Per Hour
P.F.: Full Throttle
S.L.: Sea Level

BOLD NUMBERS: Use Auto-Rich
LIGHT NUMBERS: Use Auto-Lean
WITH TWO SPEED BLOWER: Use High blower above heavy line only

INDICATED ALTITUDE CORRECTED FOR FREE AIR TEMPERATURE.
ALLOW 170 U.S. GALS. - IMP. GALS. FOR WARM UP.
TAKE-OFF AND CLIMB TO 5000 FEET ALTITUDE RETURN FUEL FLOWS TO TANK.
USE FUEL FROM TANKS IN THE FOLLOWING ORDER:
REFER TO "SPECIFIC ENGINE FLIGHT CHART" FOR ADDITIONAL ENGINE OPERATION DATA.

RANGES SHOWN ARE 90% OF FLIGHT TEST VALUES.

Flight Operation Chart (one propeller feathered) 4 Sheets

MODEL(S) B-17F		FLIGHT OPERATION INSTRUCTION CHART		EXTERNAL LOAD ITEMS	
3 ENGINE OPERATION		SHEET 2 OF 4 SHEETS		1 FEATHERED PROPELLER	
GR. WT. 55,000		TO 50,000		POUNDS	
CONDITION	R.P.M.	M.P.	MIXTURE POSITION	DURATION IN MIN.	U.S. G.P.H.
TAKEOFF	2500	116	A.R.	5	1156
MILITARY POWER	2500	116	A.R.	5	1156
ENGINE IS:	R-1820-97				
INSTRUCTIONS FOR USING CHART: Select figure in fuel column equal to or less than total amount of fuel in airplane. Move horizontally to the right or left and select a figure equal to or greater than the air miles to be flown. Vertically below and opposite desired cruising altitude read optimum cruising conditions. NOTES: (A) Avoid continuous cruising in Column 1 in the upper left corner of chart.					
ALTERNATE CRUISING CONDITIONS					
(NO WIND)					
I NORMAL RATED (MAX. CONT.)		II		III	
RANGE IN AIR MILES		RANGE IN AIR MILES		RANGE IN AIR MILES	
STATUTE	NAUTICAL	STATUTE	NAUTICAL	STATUTE	NAUTICAL
AT S.L. AT 20,000	AT S.L. AT 20,000	160 U.S. GALLONS NOT AVAILABLE IN FLIGHT.			
U.S. GALLS.	U.S. GALLS.	U.S. GALLS.	U.S. GALLS.	U.S. GALLS.	U.S. GALLS.
2360	2200	1360	1500	1730	1600
2000	2000	1240	1370	1520	1400
1800	1600	1110	1240	1420	1260
1600	1400	990	1100	1260	1100
1400	1200	870	960	1100	960
1200	1000	740	830	950	830
1000	800	620	690	790	690
800	600	500	550	630	550
600	400	370	410	470	410
400	200	250	280	320	280
200	100	130	140	160	140
OPERATING DATA		OPERATING DATA		OPERATING DATA	
R.P.M.	MIX-TURE	MIX-TURE	MIX-TURE	MIX-TURE	MIX-TURE
2300	A.R. 36 310	2200	A.R. 33 239	2100	A.L. 31 191
2300	A.R. 38 310	2200	A.R. 33 236	2100	A.L. 31 192
2300	A.R. 38 310	2150	A.R. 32.5 232	2100	A.L. 31 189
2300	A.R. 38 310	2150	A.R. 32 227	2100	A.L. 31 192
2300	A.R. 38 310	2150	A.R. 32 221	2100	A.L. 31 189
2300	A.R. 38 310	2150	A.R. 31 213	2100	A.L. 31 185
OPERATING DATA		OPERATING DATA		OPERATING DATA	
DENSITY	ALT. IN FEET	DENSITY	ALT. IN FEET	DENSITY	ALT. IN FEET
30000	30000	25000	25000	20000	20000
15000	15000	12000	12000	9000	9000
6000	6000	3000	3000	S.L.	S.L.
OPERATING DATA		OPERATING DATA		OPERATING DATA	
R.P.M.	MIX-TURE	R.P.M.	MIX-TURE	R.P.M.	MIX-TURE
520	A.R. 36 310	350	A.R. 36 310	170	A.R. 36 310
450	A.R. 38 310	300	A.R. 38 310	150	A.R. 38 310
300	A.R. 38 310	200	A.R. 38 310	150	A.R. 38 310

INDICATED ALTITUDE CORRECTED FOR FREE AIR TEMPERATURE.
 ALLOW 150 U.S. GALLS. - IMP. GALLS. FOR WARM UP.
 TAKE-OFF AND CLIMB TO 5000 FEET ALTITUDE
 RETURN FUEL FLOWS TO TANK.
 USE FUEL FROM TANKS IN THE FOLLOWING ORDER:
 REFER TO "SPECIFIC ENGINE FLIGHT CHART" FOR ADDITIONAL ENGINE OPERATION DATA.
 RANGES SHOWN ARE 90% OF FLIGHT TEST VALUES.

R.P.M.: Revolutions Per Minute
 M.P.: Manifold Pressure (In. Hg)
 U.S.G.P.H.: U.S. Gallons Per Hour
 IMP.G.P.H.: Imperial Gallons Per Hour
 F.F.: Full Thrust
 S.L.: Sea Level

Flight Operation Chart (one propeller feathered) 4 Sheets

MODEL (S) B-17F		FLIGHT OPERATION INSTRUCTION CHART		EXTERNAL LOAD ITEMS	
3 ENGINE OPERATION		SHEET 3 OF 4 SHEETS		1 FEATHERED PROPELLER	
GR. WT. 50,000		TO 45,000		POUNDS	
CONDITION	R.P.M.	M.P. (IN HG.) POSITION	MIXTURE POSITION	DURATION (IN MIN.) U.S. G.P.H.	IMP. G.P.H.
TAKE-OFF	2500	46	A. R.	5	456
MILITARY POWER	2500	46	A. R.	5	456
ENGINE IS:	R-1820-97				
INSTRUCTIONS FOR USING CHART: Select figure in fuel column equal to or less than total amount of fuel in airplane. Move horizontally to the right or left and select a figure equal to or greater than the air miles to be flown. Vertically below and opposite desired cruising altitude read optimum cruising conditions. NOTES: (A) Avoid continuous cruising in Column 1 in the upper left corner of chart.					
1 NORMAL RATED (MAX. CONT.)			NO RESERVE FUEL ALLOWANCE		
RANGE IN AIR MILES		III		IV (MAX. RANGE)	
STATUTE	NAUTICAL	STATUTE	NAUTICAL	STATUTE	NAUTICAL
AT 5,000 FT. ALT.	AT 5,000 FT. ALT.	AT 5,000 FT. ALT.	AT 5,000 FT. ALT.	AT 5,000 FT. ALT.	AT 5,000 FT. ALT.
1170	1080	1360	1180	1500	1300
1900	1200	1190	1040	1320	1150
810	880	1020	880	1130	980
680	590	850	740	940	820
540	470	680	590	760	650
410	360	510	440	570	500
270	240	340	300	360	330
140	120	170	150	190	170
FUEL U.S. GALS.		FUEL U.S. GALS.		FUEL U.S. GALS.	
1732	1800	1400	1200	1000	800
1300	1100	900	800	600	400
1000	800	600	400	300	200
OPERATING DATA		OPERATING DATA		OPERATING DATA	
R.P.M.	I.A.S. M.P.H.	R.P.M.	I.A.S. M.P.H.	R.P.M.	I.A.S. M.P.H.
2300	151 A.R.	2100	141 A.L.	2050	141 A.L.
2300	163 A.R.	2100	149 A.L.	2050	149 A.L.
2300	171 A.R.	2100	155 A.L.	2050	155 A.L.
2300	178 A.R.	2100	160 A.L.	2050	158 A.L.
2300	183 A.R.	2100	164 A.L.	2050	162 A.L.
2300	187 A.R.	2100	168 A.L.	2050	162 A.L.
2300	192 A.R.	2100	171 A.L.	2050	162 A.L.
2300	198 A.R.	2100	171 A.L.	2050	162 A.L.
DENSITY ALT. IN FEET		DENSITY ALT. IN FEET		DENSITY ALT. IN FEET	
30000	25000	20000	15000	12000	9000
LEGEND		LEGEND		LEGEND	
① INDICATED ALTITUDE CORRECTED FOR FREE AIR TEMPERATURE	② ALLOW 132 U.S. GALS. - IMP. GALS. FOR WARM UP, TAKEOFF AND CLIMB TO 5,000-FOOT ALTITUDE	③ RETURN FUEL FLOWS TO TANK	④ USE FUEL FROM TANKS IN THE FOLLOWING ORDER	⑤ REFER TO "SPECIFIC ENGINE FLIGHT CHART" FOR ADDITIONAL ENGINE OPERATION DATA.	⑥ RANGES SHOWN ARE 90% OF FLIGHT TEST VALUES.

Flight Operation Chart (one propeller feathered) 4 Sheets

MODEL (S) B-17F		FLIGHT OPERATION INSTRUCTION CHART				EXTERNAL LOAD ITEMS				
3 ENGINE OPERATION		SHEET 4 OF 4 SHEETS				1 FEATHERED PROPELLER				
FORM AC311A		GR. WT. 45,000 TO 40,000 POUNDS								
CONDITION	R.P.M.	M.P.	BLOWER POSITION	DURATION IN MIN.	U.S. G.P.H.	IMP. G.P.H.	INSTRUCTIONS FOR USING CHART: Select figure in fuel column equal to or less than total amount of fuel in airplane. Move horizontally to the right or left and select a figure equal to or greater than the air miles to be flown. Vertically below and opposite desired cruising altitude read optimum cruising conditions. NOTES: (A) Avoid continuous cruising in Column I in the upper left corner of chart.			
TAKE-OFF	2500	46	A.R.	5	458	-	except in emergency. (B) Columns III, IV & V toward the right progressively give increase in range of sacrifice in speed. (C) Manifold Pressure (M.P.), Gallons Per Hour (G.P.H.), one approximate maximum values for reference. (D) For quick reference, take-off and military power data are listed in the upper left corner of chart.			
MILITARY POWER	2500	46	A.R.	5	458	-				
ENGINE ID	R-1620-97									
ALTERNATE CRUISING CONDITIONS										
(NO WIND)										
I NORMAL RATED (MAX. CONT.)										
RANGE IN AIR MILES		RANGE IN AIR MILES		RANGE IN AIR MILES		RANGE IN AIR MILES		RANGE IN AIR MILES		FUEL
STATUTE	NAUTICAL	STATUTE	NAUTICAL	STATUTE	NAUTICAL	STATUTE	NAUTICAL	STATUTE	NAUTICAL	U.S. GALS.
AT S.L. AT 25,000	AT S.L. AT 25,000	AT S.L. AT 25,000	AT S.L. AT 25,000	AT S.L. AT 25,000	AT S.L. AT 25,000	AT S.L. AT 25,000	AT S.L. AT 25,000	AT S.L. AT 25,000	AT S.L. AT 25,000	②
700	670	880	770	960	850	1050	910	1140	1000	1000
560	490	700	610	770	670	840	730	910	800	800
430	370	540	470	590	510	640	560	690	600	600
280	240	350	300	340	300	420	370	450	400	400
140	120	180	160	170	150	210	180	230	200	200
OPERATING DATA		OPERATING DATA		OPERATING DATA		OPERATING DATA		OPERATING DATA		OPERATING DATA
R.P.M.	I.A.S. MIX-TURE M.P.H.	U.S. M.P. IN. Hg	U.S. G.P. H.	R.P.M.	I.A.S. MIX-TURE M.P.H.	U.S. M.P. IN. Hg	U.S. G.P. H.	R.P.M.	I.A.S. MIX-TURE M.P.H.	U.S. M.P. IN. Hg
2300	144 A.R.	38 310	30000	2100	148 A.L.	31 180	2050	144 A.L.	30 180	30000
2300	159 A.R.	38 310	25000	2100	154 A.L.	31 178	2050	148 A.L.	30 157	25000
2300	169 A.R.	38 310	20000	2100	159 A.L.	31 175	2050	153 A.L.	29 5155	20000
2300	178 A.R.	38 310	15000	2100	149 A.L.	31 199	2050	155 A.L.	30 5 171	15000
2300	183 A.R.	38 310	12000	2100	155 A.L.	31 196	2050	168 A.L.	30 186	12000
2300	186 A.R.	38 310	9000	2100	161 A.L.	31 194	2050	168 A.L.	30 181	9000
2300	190 A.R.	38 310	6000	2100	165 A.L.	31 191	2050	161 A.L.	29 142	6000
2300	194 A.R.	38 310	3000	2100	169 A.L.	31 186	2050	168 A.L.	29 142	3000
2300	198 A.R.	38 310	S.L.	2100	173 A.L.	31 182	2050	161 A.L.	29 142	S.L.
① INDICATED ALTITUDE CORRECTED FOR FREE AIR TEMPERATURE ② ALLOW - U.S. GALS. - IMP. GALS. FOR WARM UP TAKE-OFF AND CLIMB TO - FEET ALTITUDE RETURN FUEL FLOWS TO TANK USE FUEL FROM TANKS IN THE FOLLOWING ORDER REFER TO "SPECIFIC ENGINE FLIGHT CHART" FOR ADDITIONAL ENGINE OPERATION DATA. RANGES SHOWN ARE 90% OF FLIGHT TEST VALUES.										

Flight Operation Chart (one propeller feathered) 4 Sheets

INDICATED AIR SPEED
M.P. - Manifold Pressure (In. Hg)
U.S.G.P.H. - U.S. Gallons Per Hour
IMP.G.P.H. - Imperial Gallons Per Hour
A.L. - Full Throttle
S.L. - See Level

SOLD NUMBERS: Use Air-Rick
LIGHT NUMBERS: Use Air-Lean
WITH TWO SPEED BLOWER: Use High
blower above heavy line only

WSP-11-1-33

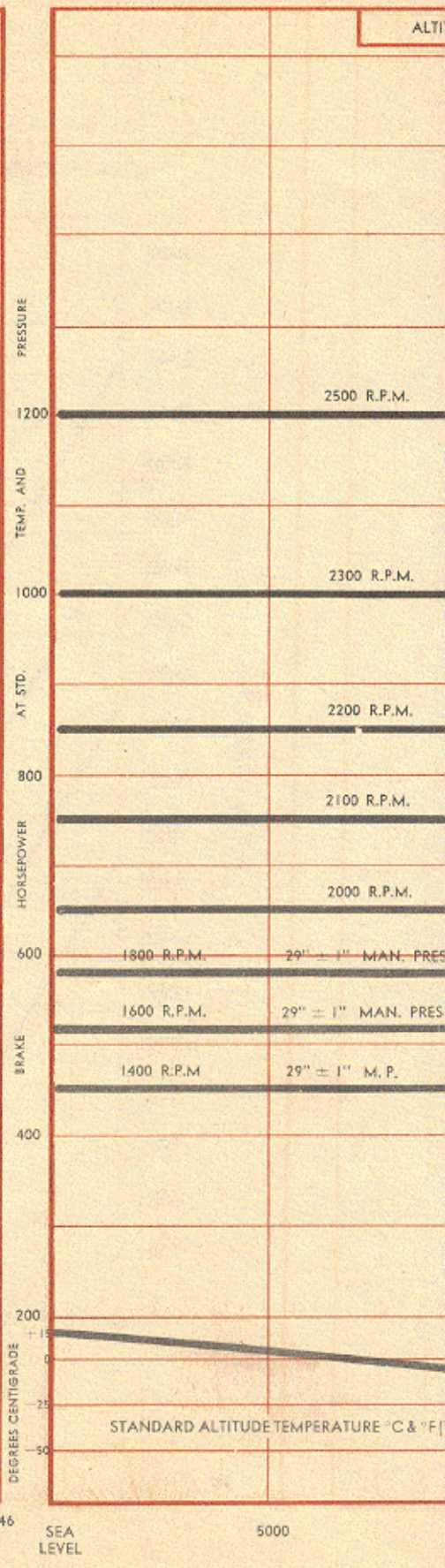
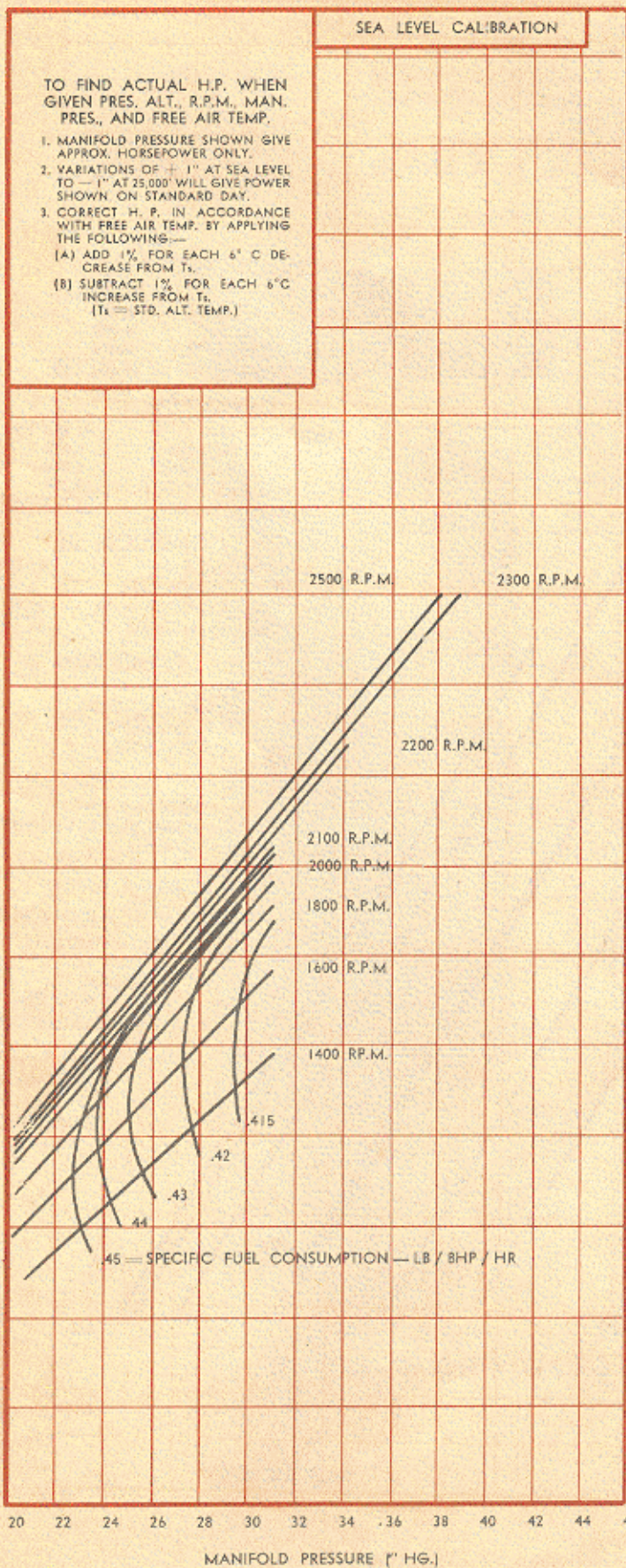

Engine Flight Calibration Curve

ALTITUDE CALIBRATION

ENGINE FLIGHT CALIBRATION CURVES

AIRPLANE MODEL	ENGINE MODEL
B - 17 E	R - 1820 - 65
B - 17 F	R - 1820 - 97

PROP. LIMITS
 REDUCTION GEAR RATIO 16:9
 COMPRESSION RATIO 6 TO 1
 SUPERCHARGER TYPE G-E TYPE B-2
 BLOWER GEAR RATIO 7.00:1
 CARBURETION—STROMBERG PD-12
 FUEL AN.VV-F-781
 100 OCTANE

NOTE

REDUCE MANIFOLD PRESS. 1.5" PER 1000' INCREASE IN ALTITUDE WHERE TURBINE R.P.M. IS CONSTANT.

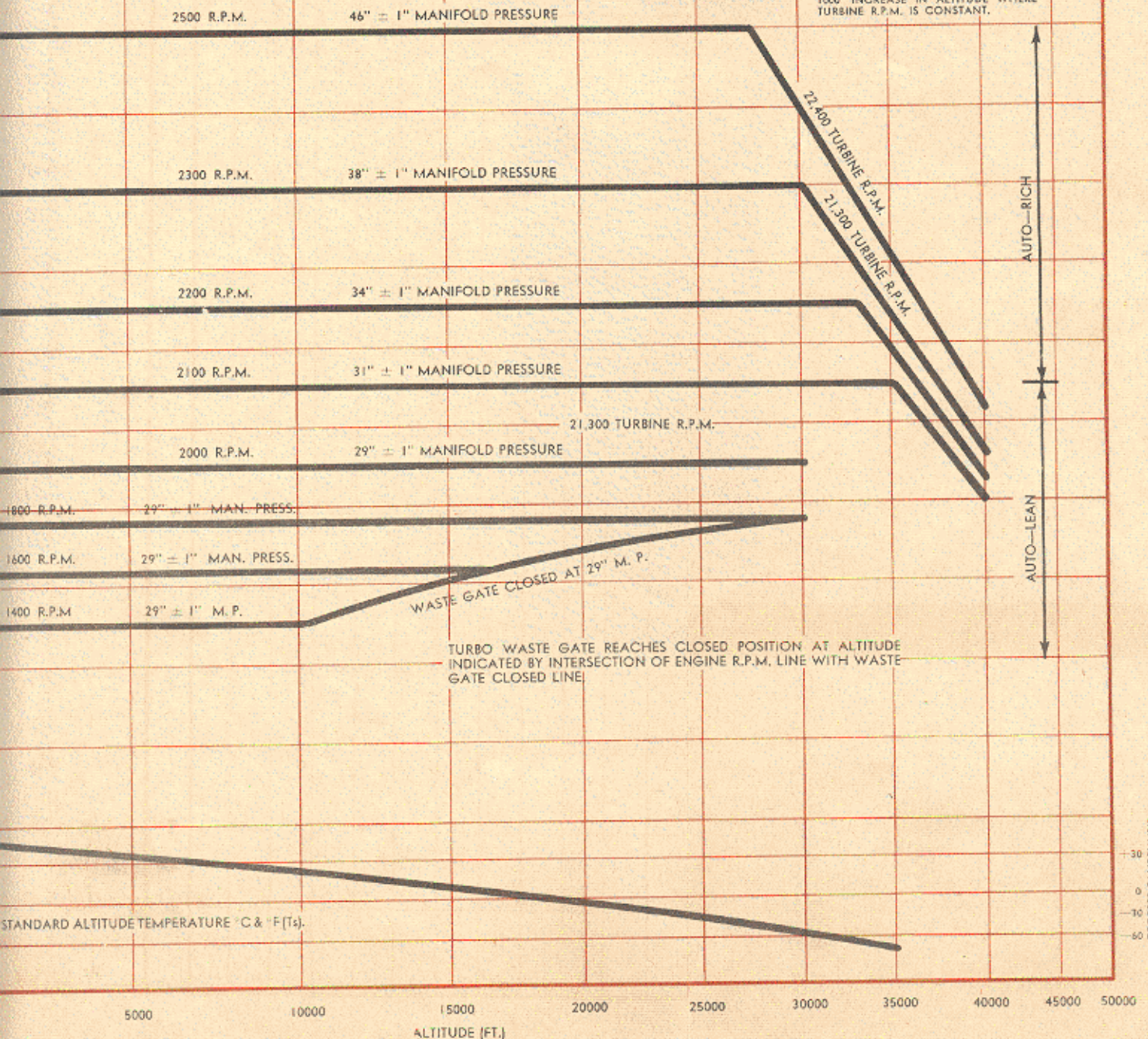

DEGREES FAHRENHEIT

LOAD CONDITIONS INCLUDE IN BASIC WEIGHT:

CREW OF NINE
NINE 50 CALIBER GUNS
3500 ROUNDS AMMUNITION EXCEPT I = 1170 ROUNDS
900 LBS. MISCELLANEOUS EQUIPMENT
144 GALLONS OIL
1500 LBS. EXTRA WING TANKS IN
CONDITIONS I, II, III, IV, V, AND VII.

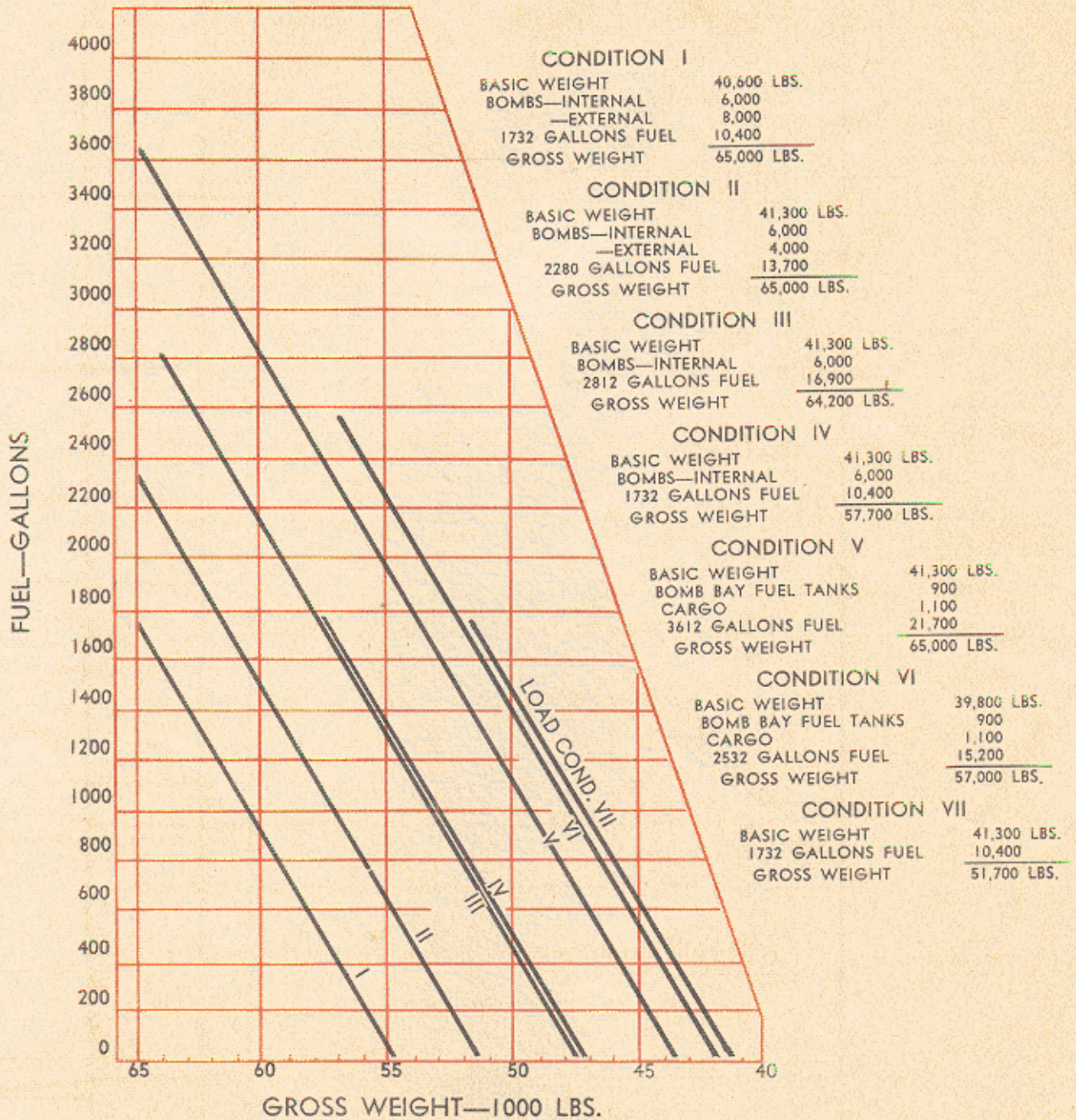

Loading Chart

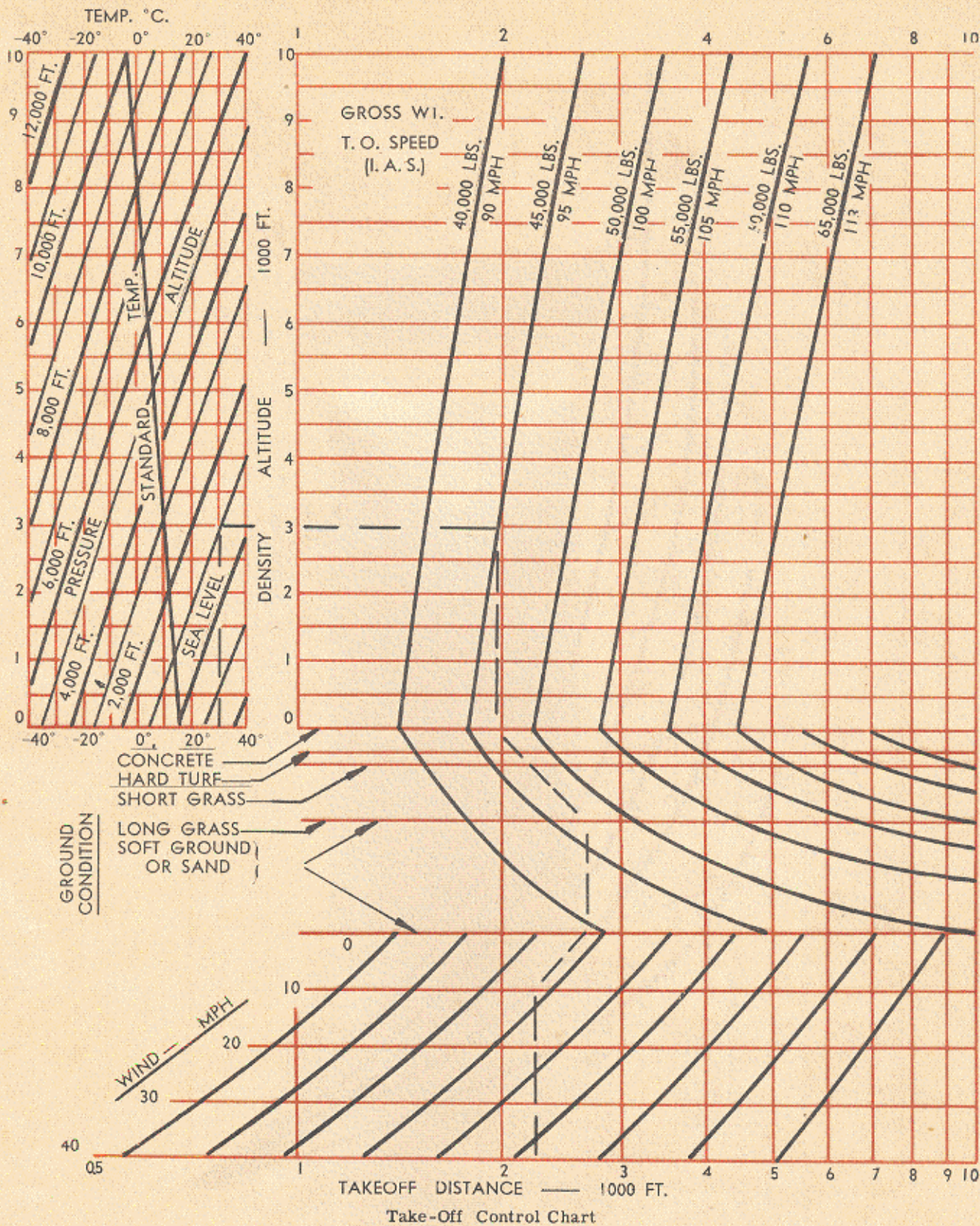

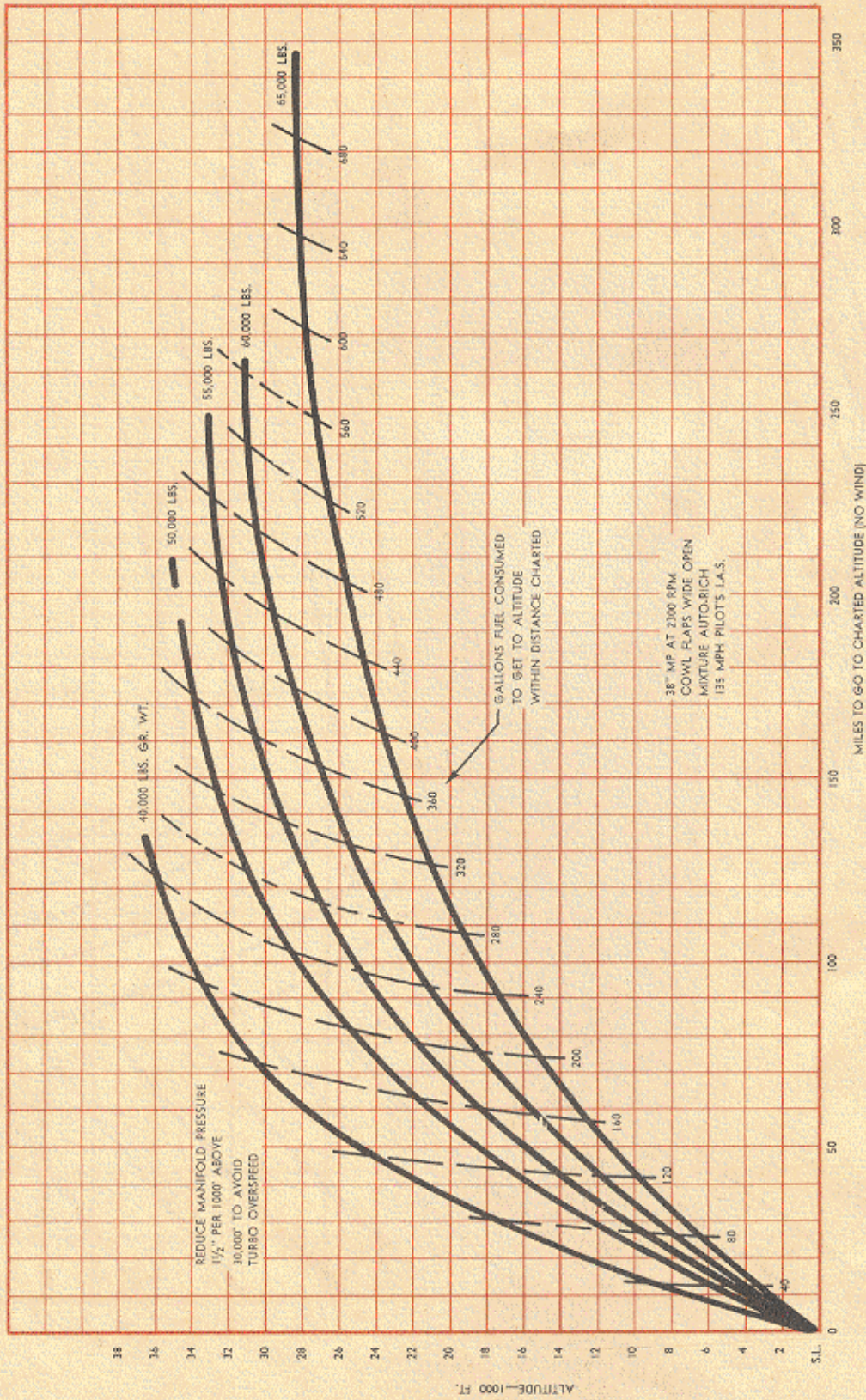

Climb Control Chart

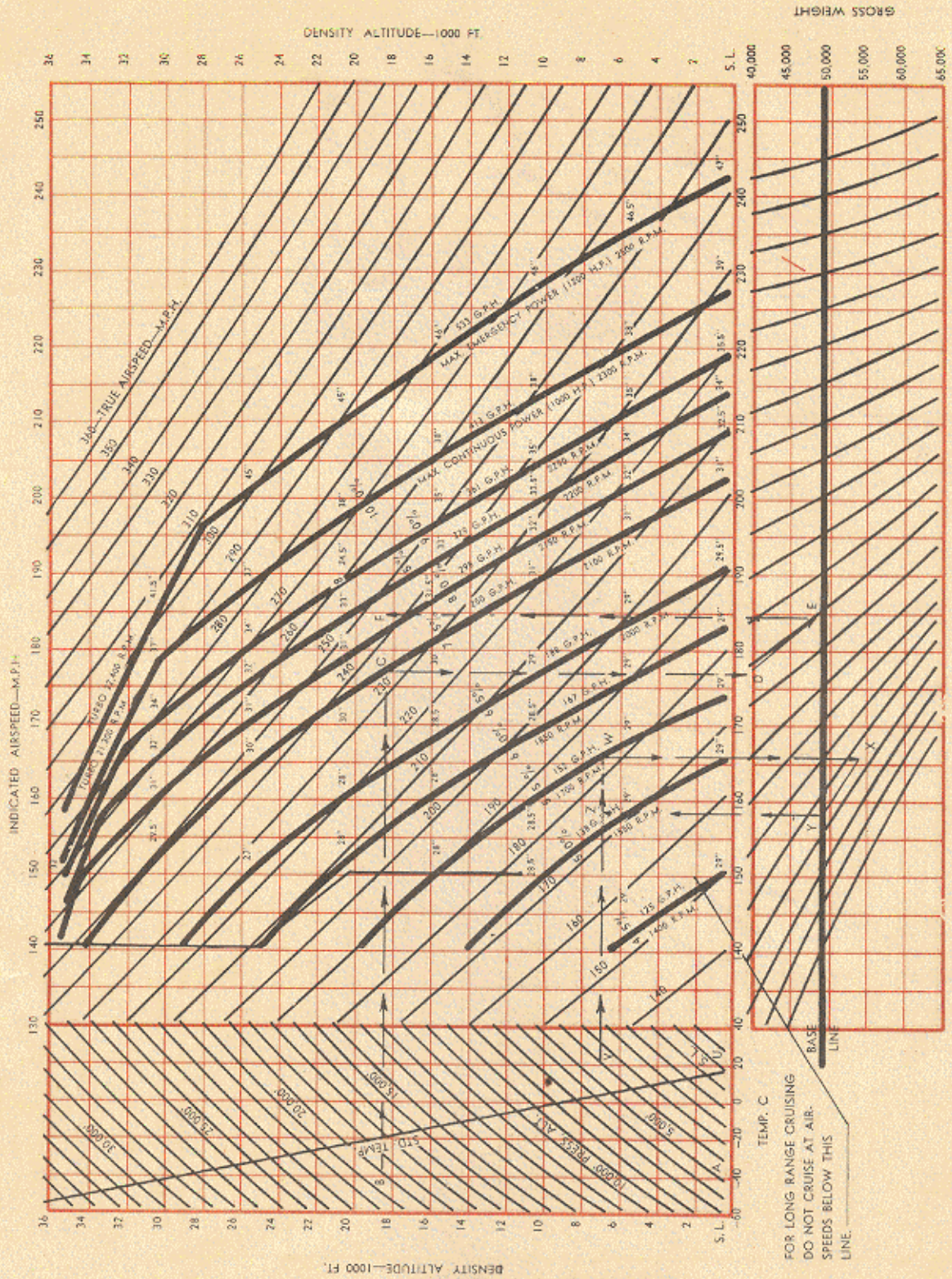

Composite Cruising Control Chart

GROSS WT. — 65,000 LBS.

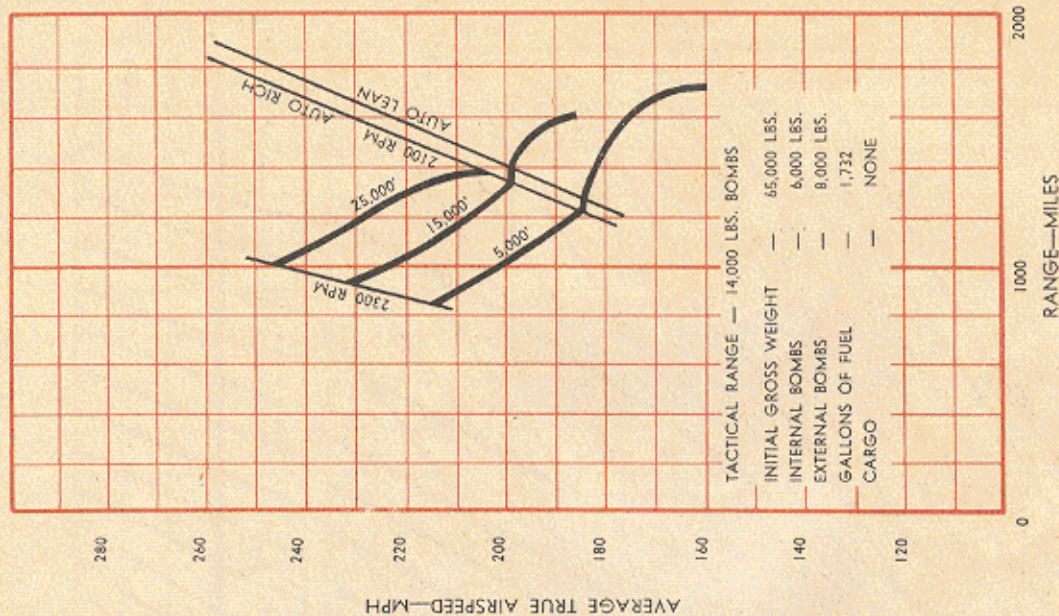

RANGE VS. AVERAGE TRUE AIRSPEED

GROSS WT. — 65,000 LBS.

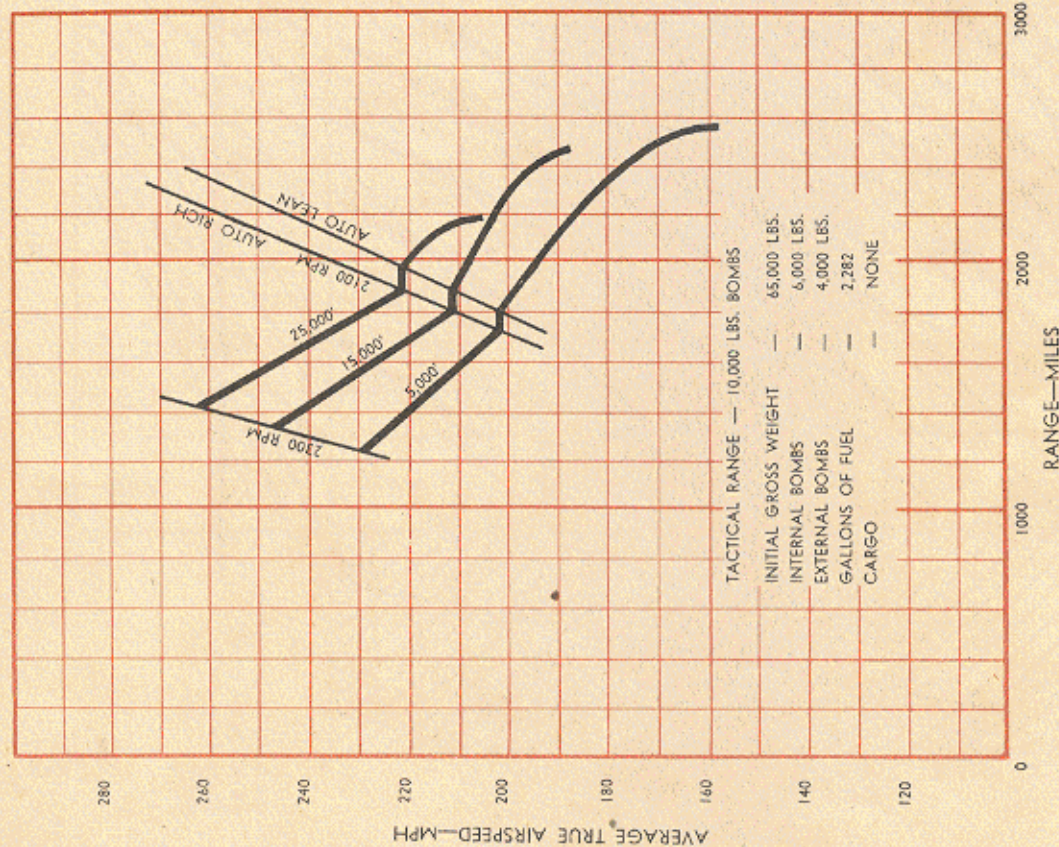

NOTE:

1. THESE RANGE VS. TRUE AIRSPEED CURVES SHOW ABSOLUTE RANGES AND ARE COMPUTED FROM INSTANTANEOUS CRUISING CONDITIONS OF ALTITUDE, POWER, AND FUEL FLOW.
2. NO ALLOWANCE IS MADE FOR WARMUP, TAKEOFF, CLIMB, DESCENT OR HEADWINDS.
3. BOMBS ARE CONSIDERED CARRIED HALF THE DISTANCE OF FLIGHT.

Tactical Range Charts

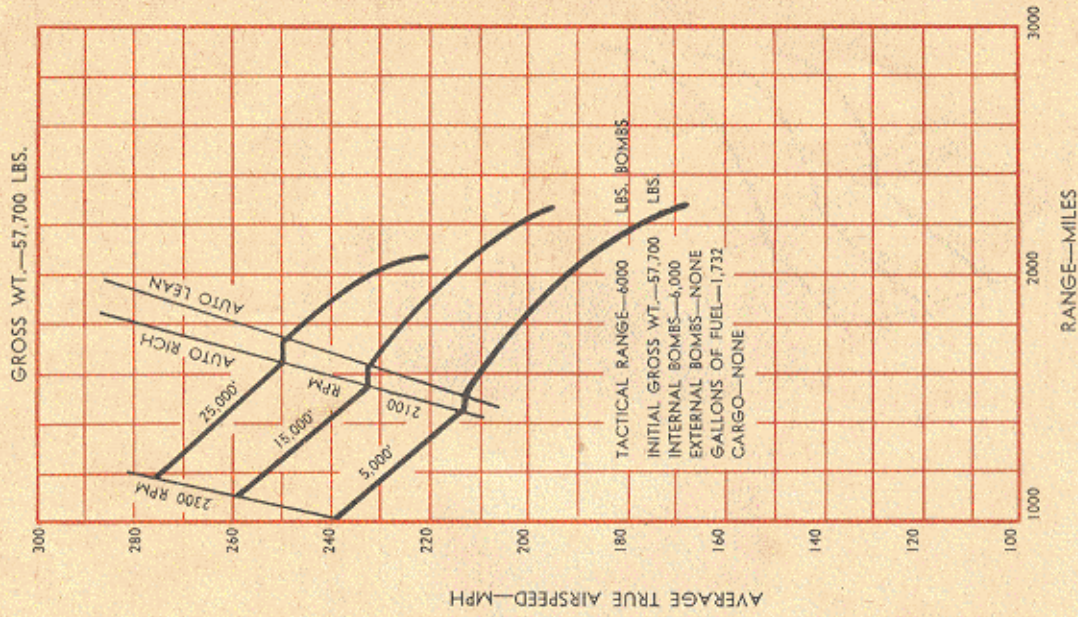

RANGE VS. AVERAGE TRUE AIRSPEED

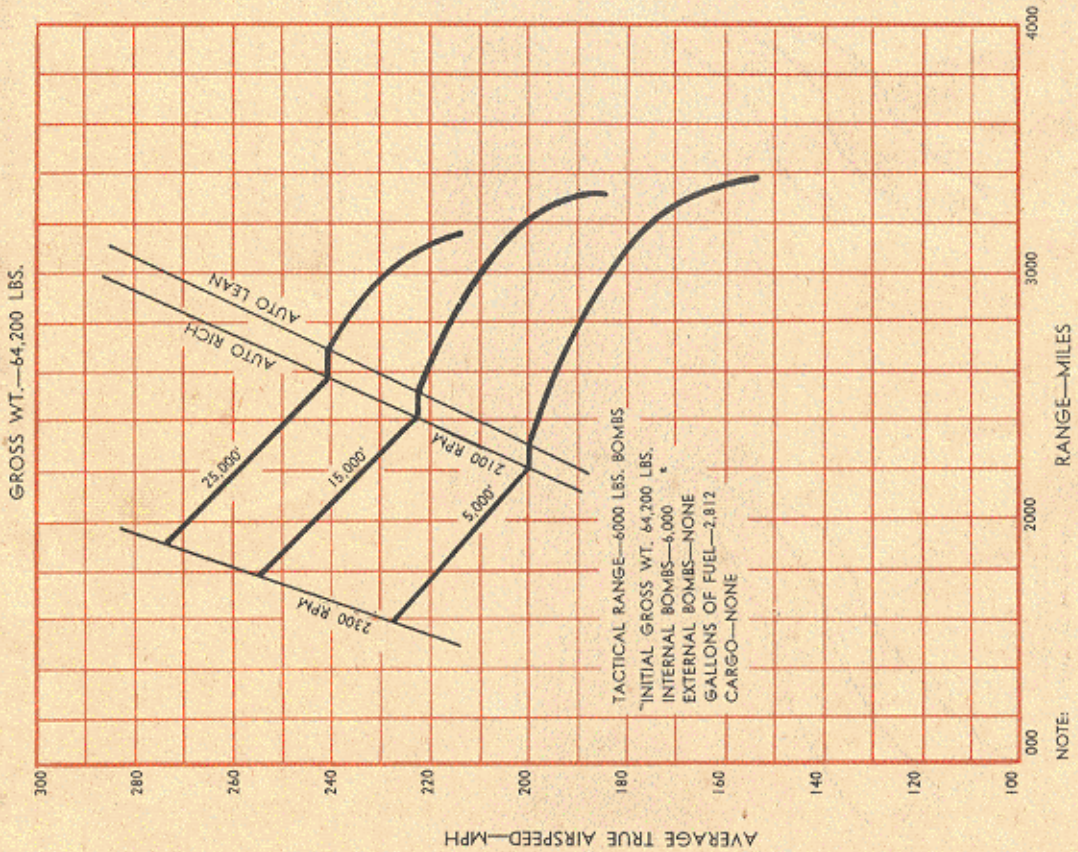

NOTE:

1. THESE RANGE VS. AVERAGE TRUE AIRSPEED CURVES SHOW ABSOLUTE RANGES AND ARE COMPUTED FROM INSTANTANEOUS CRUISING CONDITIONS OF ALTITUDE, POWER, AND FUEL FLOW.
2. NO ALLOWANCE IS MADE FOR WARMUP, TAKEOFF, CLIMB, DESCENT OR HEADWINDS.
3. BOMBS ARE CONSIDERED CARRIED HALF THE DISTANCE OF FLIGHT.

Tactical Range Charts

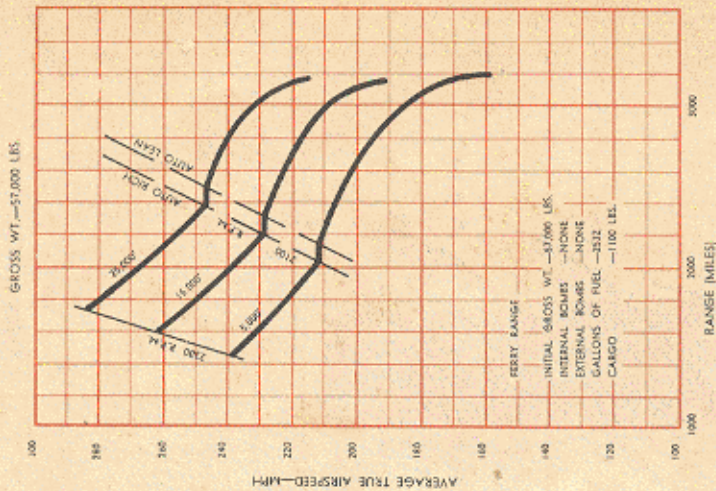

RANGE VS. AVERAGE TRUE AIRSPEED

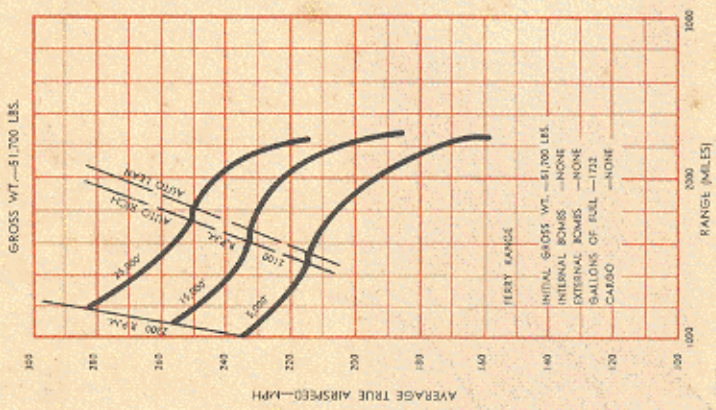

NOTE:
1. THESE RANGE VS. TRUE AIRSPEED CURVES SHOW ABSOLUTE RANGES AND ARE COMPUTED FROM INSTANTANEOUS CRUISING CONDITIONS OF ALTITUDE, POWER, AND FUEL FLOW.
2. NO ALLOWANCE IS MADE FOR WINDS, TAKEOFF, DESCENT, OR PLOWING.
3. BOMBS ARE CONSIDERED CARRIED HALF OF THE DISTANCE OF FLIGHT.

Ferry Range Charts

